

Draft **ETSI EN 303 659** V1.0.0 (2024-11)



**Short Range Devices (SRD) in Data Networks;
Radio equipment to be used in the frequency ranges
865 MHz to 868 MHz and 915 MHz to 919,4 MHz;
Harmonised Standard for access to radio spectrum**

ReferenceDEN/ERM-TG28-561

Keywordsharmonised standard, radio, SRD

ETSI

650 Route des Lucioles
F-06921 Sophia Antipolis Cedex - FRANCE

Tel.: +33 4 92 94 42 00 Fax: +33 4 93 65 47 16

Siret N° 348 623 562 00017 - APE 7112B
Association à but non lucratif enregistrée à la
Sous-Préfecture de Grasse (06) N° w061004871

Important notice

The present document can be downloaded from the
[ETSI Search & Browse Standards](#) application.

The present document may be made available in electronic versions and/or in print. The content of any electronic and/or print versions of the present document shall not be modified without the prior written authorization of ETSI. In case of any existing or perceived difference in contents between such versions and/or in print, the prevailing version of an ETSI deliverable is the one made publicly available in PDF format on [ETSI deliver](#) repository.

Users should be aware that the present document may be revised or have its status changed,
this information is available in the [Milestones listing](#).

If you find errors in the present document, please send your comments to
the relevant service listed under [Committee Support Staff](#).

If you find a security vulnerability in the present document, please report it through our
[Coordinated Vulnerability Disclosure \(CVD\)](#) program.

Notice of disclaimer & limitation of liability

The information provided in the present deliverable is directed solely to professionals who have the appropriate degree of experience to understand and interpret its content in accordance with generally accepted engineering or other professional standard and applicable regulations.

No recommendation as to products and services or vendors is made or should be implied.
In no event shall ETSI be held liable for loss of profits or any other incidental or consequential damages.

Any software contained in this deliverable is provided "AS IS" with no warranties, express or implied, including but not limited to, the warranties of merchantability, fitness for a particular purpose and non-infringement of intellectual property rights and ETSI shall not be held liable in any event for any damages whatsoever (including, without limitation, damages for loss of profits, business interruption, loss of information, or any other pecuniary loss) arising out of or related to the use of or inability to use the software.

Copyright Notification

No part may be reproduced or utilized in any form or by any means, electronic or mechanical, including photocopying and microfilm except as authorized by written permission of ETSI.

The content of the PDF version shall not be modified without the written authorization of ETSI.

The copyright and the foregoing restriction extend to reproduction in all media.

© ETSI 2024.
All rights reserved.

Contents

Intellectual Property Rights	9
Foreword.....	9
Modal verbs terminology.....	10
Introduction	10
1 Scope	11
2 References	11
2.1 Normative references	11
2.2 Informative references.....	11
3 Definition of terms, symbols and abbreviations.....	12
3.1 Terms.....	12
3.2 Symbols.....	15
3.3 Abbreviations	16
4 Technical requirements specifications	17
4.1 Environmental profile.....	17
4.2 General conditions for operating	17
4.2.1 Wanted performance criteria.....	17
4.2.2 Types and Operating Frequency Bands	17
4.2.3 Operating conditions.....	18
4.3 All equipment conformance requirements	18
4.3.1 Unwanted emissions in the spurious domain	18
4.3.1.1 Applicability.....	18
4.3.1.2 Description	19
4.3.1.2.1 Spectrum mask in the transmitter spurious domain.....	19
4.3.1.2.2 Unwanted emissions for all other modes.....	19
4.3.1.3 Limits	19
4.3.1.4 Conformance.....	19
4.4 Transmitter conformance requirements.....	20
4.4.1 Effective radiated power	20
4.4.1.1 Applicability.....	20
4.4.1.2 Description.....	20
4.4.1.3 Limits	20
4.4.1.4 Conformance.....	20
4.4.2 Maximum occupied bandwidth.....	20
4.4.2.1 Applicability.....	20
4.4.2.2 Description	20
4.4.2.3 Limits	20
4.4.2.4 Conformance.....	20
4.4.3 Frequency Error	21
4.4.3.1 Applicability.....	21
4.4.3.2 Description	21
4.4.3.3 Limits	21
4.4.3.4 Conformance.....	21
4.4.4 Transmitter Signal at the edges of the Transmitter Operating Frequency Band	21
4.4.4.1 Applicability.....	21
4.4.4.2 Description	21
4.4.4.3 Limits	21
4.4.4.4 Conformance.....	22
4.4.5 Transient power	22
4.4.5.1 Applicability.....	22
4.4.5.2 Description.....	22
4.4.5.3 Reference limits	22
4.4.5.4 Conformance.....	22
4.4.6 Spectrum mask in the transmitter out-of-band domain.....	22
4.4.6.1 Applicability.....	22

4.4.6.2	Description	22
4.4.6.3	Limits	23
4.4.6.4	Conformance	23
4.4.7	Adjacent Channel Power	23
4.4.7.1	Applicability	23
4.4.7.2	Description	24
4.4.7.3	Limits	24
4.4.7.4	Conformance	24
4.4.8	Spectrum mask at permitted frequency band edges	24
4.4.8.1	Applicability	24
4.4.8.2	Description	24
4.4.8.3	Limits	25
4.4.8.4	Conformance	25
4.4.9	Duty Cycle	25
4.4.9.1	Applicability	25
4.4.9.2	Description	25
4.4.9.3	Limit	25
4.4.9.4	Conformance	26
4.4.10	Adaptive power control	26
4.4.10.1	Applicability	26
4.4.10.2	Description	26
4.4.10.3	Limits	26
4.4.10.4	Conformance	26
4.4.11	Transmitter behaviour under low-voltage conditions	26
4.4.11.1	Applicability	26
4.4.11.2	Description	26
4.4.11.3	Limits	27
4.4.11.4	Conformance	27
4.5	Receiver conformance requirements	27
4.5.1	Receiver sensitivity	27
4.5.1.1	Applicability	27
4.5.1.2	Description	27
4.5.1.3	Limits	27
4.5.1.4	Conformance	27
4.5.2	Adjacent channel selectivity	27
4.5.2.1	Applicability	27
4.5.2.2	Description	28
4.5.2.3	Limits	28
4.5.2.4	Conformance	28
4.5.3	Spurious response rejection	28
4.5.3.1	Applicability	28
4.5.3.2	Description	28
4.5.3.3	Limits	28
4.5.3.4	Conformance	28
4.5.4	Blocking	28
4.5.4.1	Applicability	28
4.5.4.2	Description	29
4.5.4.3	Limits	29
4.5.4.4	Conformance	29
4.5.5	Receiver maximum input signal level	29
4.5.5.1	Applicability	29
4.5.5.2	Description	29
4.5.5.3	Limits	29
4.5.5.4	Conformance	29
4.6	Functional requirements	30
4.6.1	Network Access Point	30
4.6.1.1	Applicability	30
4.6.1.2	Description	30
4.6.1.3	Limits	30
4.6.1.4	Conformance	30
4.6.2	Under the control of a Master NAP	30
4.6.2.1	Applicability	30

4.6.2.2	Description	30
4.6.2.3	Limits	30
4.6.2.4	Conformance	31
4.6.3	Master NAP	31
4.6.3.1	Applicability	31
4.6.3.2	Description	31
4.6.3.3	Limits	31
4.6.3.4	Conformance	31
5	Testing for compliance with technical requirements	31
5.1	Environmental conditions for testing	31
5.1.1	General considerations	31
5.1.2	Normal test conditions	31
5.1.2.1	Normal temperature and humidity for the tests	31
5.1.2.2	Normal power source for the tests	32
5.1.2.2.1	Mains voltage	32
5.1.2.2.2	Battery power sources	32
5.1.3	Extreme conditions for the tests	32
5.1.3.1	Extreme temperatures range	32
5.1.3.2	Extreme test source voltage	32
5.1.3.2.1	Mains voltage	32
5.1.3.2.2	Lead-acid battery power sources	32
5.1.3.2.3	Other power sources	32
5.1.3.3	Test conditions	32
5.2	General considerations for testing	33
5.2.0	General considerations	33
5.2.1	Presentation of the EUT for testing purposes	33
5.2.1.1	Choice of model for testing	33
5.2.1.1.1	General considerations	33
5.2.1.1.2	EUT with an external RF connector	34
5.2.1.1.3	EUT without an external RF connector	34
5.2.2	Test power source	34
5.2.2.1	General considerations	34
5.2.2.2	External test power source	35
5.2.2.3	Internal test power source	35
5.2.3	Thermal test conditions	35
5.2.4	Conducted measurements	35
5.2.5	Radiated measurements	35
5.2.6	Applicable measurement methods	35
5.2.7	Test signals	36
5.2.8	Measuring receiver	37
5.2.8.1	General considerations	37
5.2.8.2	Reference Bandwidth	37
5.2.9	Signal Threshold	38
5.3	All equipment conformance requirements	38
5.3.1	Unwanted emissions in the spurious domain	38
5.3.1.1	Test conditions for the spectrum mask in the transmitter spurious domain	38
5.3.1.2	Test conditions for Rx and all other modes	39
5.3.1.3	Measurement procedure	39
5.3.1.3.1	Radiated measurement	39
5.3.1.3.2	Conducted measurement	41
5.3.1.3.3	Measurement of emissions identified during the pre-scan	42
5.4	Conformance methods of measurement for transmitters	43
5.4.1	Effective radiated power	43
5.4.1.1	General	43
5.4.1.2	Radiated measurement procedure	43
5.4.1.2.1	Test conditions	43
5.4.1.2.2	Measurement procedure	43
5.4.1.3	Conducted measurement procedure	44
5.4.1.3.1	Test conditions	44
5.4.1.3.2	Measurement procedure	44
5.4.2	Maximum occupied bandwidth	44

5.4.2.1	Test conditions	44
5.4.2.2	Radiated measurement	44
5.4.2.3	Conducted measurement	44
5.4.2.4	Measurement procedure	45
5.4.3	Frequency error	46
5.4.3.1	Test conditions	46
5.4.3.2	Radiated measurement	46
5.4.3.3	Conducted measurement	46
5.4.3.4	Measurement procedure for D-M1 test signal	46
5.4.3.5	Measurement procedure for other test signal	47
5.4.4	Transmitter Signal at the edges of the TxOFB	47
5.4.4.1	Test condition	47
5.4.4.2	Radiated measurement	48
5.4.4.3	Conducted measurement	48
5.4.4.4	Measurement procedure	48
5.4.5	Transient power	48
5.4.5.1	General	48
5.4.5.2	Radiated measurement	49
5.4.5.3	Conducted measurement	49
5.4.5.4	Measurement procedure	49
5.4.6	Spectrum mask in the transmitter out-of-band domain	50
5.4.6.1	Test conditions	50
5.4.6.2	Radiated measurement	50
5.4.6.3	Conducted measurement	50
5.4.6.4	Measurement procedure	50
5.4.7	Adjacent channel power	51
5.4.7.1	Test conditions	51
5.4.7.2	Radiated measurement	51
5.4.7.3	Conducted measurement	51
5.4.7.4	Measurement procedure	51
5.4.8	Transmitter spectrum mask at permitted frequency band edges	52
5.4.8.1	Test conditions	52
5.4.8.2	Radiated measurement	52
5.4.8.3	Conducted measurement	52
5.4.8.4	Measurement procedure	52
5.4.9	Duty cycle	53
5.4.9.1	Test conditions	53
5.4.9.2	Radiated measurement	53
5.4.9.3	Conducted measurement	53
5.4.9.4	Measurement procedure	53
5.4.10	Adaptive power control	54
5.4.10.1	Test conditions	54
5.4.10.2	Radiated measurement	54
5.4.10.3	Conducted measurement	54
5.4.10.4	Measurement procedure	54
5.4.11	Transmitter behaviour under low voltage conditions	55
5.4.11.1	Test conditions	55
5.4.11.2	Radiated measurement	55
5.4.11.3	Conducted measurement	55
5.4.11.4	Measurement procedure	56
5.5	Conformance methods of measurement for receivers	56
5.5.1	Receiver sensitivity	56
5.5.1.1	Test conditions	56
5.5.1.2	Radiated measurement	56
5.5.1.3	Conducted measurement	56
5.5.1.4	Measurement procedure	56
5.5.2	Adjacent channel selectivity	57
5.5.2.1	Test conditions	57
5.5.2.2	Radiated measurement	57
5.5.2.3	Conducted measurement	58
5.5.2.4	Measurement procedure	58
5.5.3	Blocking and spurious response rejection	59

5.5.3.1	Test conditions	59
5.5.3.2	Radiated measurement	59
5.5.3.3	Conducted measurement	60
5.5.3.4	Measurement procedure	60
5.5.4	Receiver maximum input signal level.....	61
5.5.4.1	Test conditions	61
5.5.4.2	Radiated measurement	61
5.5.4.3	Conducted measurement	61
5.5.4.4	Measurement procedure	62
5.6	Conformance test suites for functional requirements	62
5.6.1	General test conditions.....	62
5.6.2	Network access point	63
5.6.2.1	Test conditions	63
5.6.2.2	Measurement Procedure.....	63
5.6.3	Under the control of a Master NAP	64
5.6.3.1	Test conditions	64
5.6.3.2	Radiated measurement	64
5.6.3.3	Conducted measurement	65
5.6.3.4	Measurement procedure	65
5.6.4	Master NAP	66
5.6.4.1	Test conditions	66
5.6.4.2	Radiated measurement	66
5.6.4.3	Conducted measurement	67
5.6.4.4	Measurement procedure	67
5.7	Interpretation of the measurement results	68
Annex A (informative):	Relationship between the present document and the essential requirements of Directive 2014/53/EU	69
Annex B (normative):	Test sites and arrangements for radiated measurement	71
B.1	Introduction	71
B.2	Radiation test sites.....	71
B.2.1	Open Area Test Site	71
B.2.2	Semi Anechoic Room.....	72
B.2.3	Fully Anechoic Room	73
B.2.4	Measurement Distance	75
B.3	Antennas.....	75
B.3.1	General considerations	75
B.3.2	Measurement antenna.....	75
B.3.3	Substitution antenna	75
B.4	Guidance on the use of radiation test sites	76
B.4.1	General considerations	76
B.4.2	Power supplies for the battery powered EUT	76
B.4.3	Site preparation	76
B.5	Coupling of signals.....	77
B.5.1	General considerations	77
B.5.2	Data Signals.....	77
B.6	Measurement procedures for radiated measurement	77
B.6.1	General considerations	77
B.6.2	Radiated measurements in an OATS or SAR.....	77
B.6.3	Radiated measurements in a FAR	78
B.6.4	Substitution measurement	78
B.6.5	Radiated measurement methods for receivers	78
B.7	Guidance for testing technical requirements	79
B.7.1	General	79
B.7.2	Radio test suites and corresponding test sites.....	79
Annex C (normative):	Test Fixture	80

C.1	Description of test-fixture	80
C.2	Validation of the test-fixture in the temperature chamber.....	81
C.3	Mode of use.....	82
Annex D (normative):	T_{On} measurements.....	83
D.1	Measurement procedure	83
D.2	T _{disregard} procedure	83
Annex E (normative):	Types and restrictions - set 1	85
Annex F (informative):	Types and restrictions - set 2	87
Annex G (informative):	Maximum measurement uncertainty	88
Annex H (informative):	Guideline for Operating Channel.....	89
H.1	Operating channel calculation	89
H.2	Operating channel illustrations.....	89
Annex I (informative):	Properties of EUT	92
I.1	Rights to copy.....	92
I.2	EUT Properties.....	92
Annex J (informative):	Selection of technical parameters	93
Annex K (informative):	Applications of the masks given in clauses 4.3.1, 4.4.6 and 4.4.8.....	96
Annex L (informative):	Change history	99
History		100

Intellectual Property Rights

Essential patents

IPRs essential or potentially essential to normative deliverables may have been declared to ETSI. The declarations pertaining to these essential IPRs, if any, are publicly available for **ETSI members and non-members**, and can be found in ETSI SR 000 314: "*Intellectual Property Rights (IPRs); Essential, or potentially Essential, IPRs notified to ETSI in respect of ETSI standards*", which is available from the ETSI Secretariat. Latest updates are available on the [ETSI IPR online database](#).

Pursuant to the ETSI Directives including the ETSI IPR Policy, no investigation regarding the essentiality of IPRs, including IPR searches, has been carried out by ETSI. No guarantee can be given as to the existence of other IPRs not referenced in ETSI SR 000 314 (or the updates on the ETSI Web server) which are, or may be, or may become, essential to the present document.

Trademarks

The present document may include trademarks and/or tradenames which are asserted and/or registered by their owners. ETSI claims no ownership of these except for any which are indicated as being the property of ETSI, and conveys no right to use or reproduce any trademark and/or tradename. Mention of those trademarks in the present document does not constitute an endorsement by ETSI of products, services or organizations associated with those trademarks.

DECT™, **PLUGTESTS™**, **UMTS™** and the ETSI logo are trademarks of ETSI registered for the benefit of its Members. **3GPP™**, **LTE™** and **5G logo** are trademarks of ETSI registered for the benefit of its Members and of the 3GPP Organizational Partners. **oneM2M™** logo is a trademark of ETSI registered for the benefit of its Members and of the oneM2M Partners. **GSM®** and the GSM logo are trademarks registered and owned by the GSM Association.

Foreword

This draft Harmonised European Standard (EN) has been produced by ETSI Technical Committee Electromagnetic compatibility and Radio spectrum Matters (ERM), and is now submitted for the combined Public Enquiry and Vote phase of the ETSI Standardisation Request deliverable Approval Procedure (SRdAP)

The present document has been prepared under the Commission's standardisation request C(2015) 5376 final [i.1] to provide one voluntary means of conforming to the essential requirements of Directive 2014/53/EU on the harmonisation of the laws of the Member States relating to the making available on the market of radio equipment and repealing Directive 1999/5/EC [i.2].

Once the present document is cited in the Official Journal of the European Union under that Directive, compliance with the normative clauses of the present document given in Table A.1 confers, within the limits of the scope of the present document, a presumption of conformity with the corresponding essential requirements of that Directive and associated EFTA regulations.

Proposed national transposition dates	
Date of latest announcement of this EN (doa):	3 months after ETSI publication
Date of latest publication of new National Standard or endorsement of this EN (dop/e):	6 months after doa
Date of withdrawal of any conflicting National Standard (dow):	18 months after doa

Modal verbs terminology

In the present document "**shall**", "**shall not**", "**should**", "**should not**", "**may**", "**need not**", "**will**", "**will not**", "**can**" and "**cannot**" are to be interpreted as described in clause 3.2 of the [ETSI Drafting Rules](#) (Verbal forms for the expression of provisions).

"**must**" and "**must not**" are **NOT** allowed in ETSI deliverables except when used in direct citation.

Introduction

The present document covers devices to be deployed in the framework of Commission implementing decision (EU) 2022/172 [i.5] within the frequency range 915 MHz to 919,4 MHz frequency band and Commission implementing decision (EU) 2022/180 [i.3] within the 865 MHz to 868 MHz frequency band (band 47b), Those devices are also covered by ERC Recommendation 70-03 [i.4] Annex 2 bands c1, c3 and c4.

1 Scope

The present document specifies technical characteristics and methods of measurements for Short Range Devices (SRD) in data networks; radio equipment to be used in the frequency bands 865 MHz to 868 MHz and 915,0 MHz to 919,4 MHz.

The present document covers types of devices NAP, master NAP, NN and TN operating indoor and outdoor. These types are specified in clause 4.2.2 together with related permitted e.r.p.

NOTE 1: The availability of the frequency bands in European Union and CEPT countries can be obtained from the EFIS (<https://efis.cept.org/>) and is also listed in Appendices 1 and 3 of ERC/REC 70-03 [i.4].

NOTE 2: It should be noted that, in some countries, part or all of the band 915,0 MHz to 919,4 MHz may be unavailable, for networked and/or network based short range devices. See National Radio Interfaces (NRI) as relevant for additional guidance.

NOTE 3: For 25 mW equipment, 917,4 MHz to 919,4 MHz is the core harmonised band according to EC DEC 2022/172 [i.5].

NOTE 4: The relationship between the present document and essential requirements of article 3.2 of Directive 2014/53/EU [i.2] is given in Annex A.

2 References

2.1 Normative references

References are either specific (identified by date of publication and/or edition number or version number) or non-specific. For specific references, only the cited version applies. For non-specific references, the latest version of the referenced document (including any amendments) applies.

Referenced documents which are not found to be publicly available in the expected location might be found in [ETSI docbox](#).

NOTE: While any hyperlinks included in this clause were valid at the time of publication, ETSI cannot guarantee their long term validity.

The following referenced documents are necessary for the application of the present document.

Not applicable.

2.2 Informative references

References are either specific (identified by date of publication and/or edition number or version number) or non-specific. For specific references, only the cited version applies. For non-specific references, the latest version of the referenced document (including any amendments) applies.

NOTE: While any hyperlinks included in this clause were valid at the time of publication, ETSI cannot guarantee their long term validity.

The following referenced documents are not necessary for the application of the present document but they assist the user with regard to a particular subject area.

[i.1] [Commission Implementing Decision C\(2015\) 5376 final of 4.8.2015](#) on a standardisation request to the European Committee for Electrotechnical Standardisation and to the European Telecommunications Standards Institute as regards radio equipment in support of Directive 2014/53/EU of the European Parliament and of the Council.

[i.2] [Directive 2014/53/EU](#) of the European Parliament and of the Council of 16 April 2014 on the harmonisation of the laws of the Member States relating to the making available on the market of radio equipment and repealing Directive 1999/5/EC.

- [i.3] [Commission Implementing Decision \(EU\) 2022/180 of 8 February 2022](#) amending Decision 2006/771/EC as regards the update of harmonised technical conditions in the area of radio spectrum use for short-range devices.
- [i.4] [ERC Recommendation 70-03](#): "Relating to the use of Short Range Devices (SRD)", June 2024.
- [i.5] [Commission Implementing Decision \(EU\) 2022/172 of 7 February 2022](#) amending Implementing Decision (EU) 2018/1538 on the harmonisation of radio spectrum for use by short-range devices within the 874-876 and 915-921 MHz frequency bands.
- [i.6] Recommendation ITU-T O.153 (10/92): "Basic parameters for the measurement of error performance at bit rates below the primary rate".
- [i.7] CISPR 16 (parts 1-1 and 1-4 (2010) part 1-5 (2014)): "Specification for radio disturbance and immunity measuring apparatus and methods; Part 1: Radio disturbance and immunity measuring apparatus".
- [i.8] ETSI TR 102 273-4 (V1.2.1): "Electromagnetic compatibility and Radio spectrum Matters (ERM); Improvement on Radiated Methods of Measurement (using test site) and evaluation of the corresponding measurement uncertainties; Part 4: Open area test site".
- [i.9] ETSI TR 102 273-3 (V1.2.1): "Electromagnetic compatibility and Radio spectrum Matters (ERM); Improvement on Radiated Methods of Measurement (using test site) and evaluation of the corresponding measurement uncertainties; Part 3: Anechoic chamber with a ground plane".
- [i.10] ETSI TR 102 273-2 (V1.2.1): "Electromagnetic compatibility and Radio spectrum Matters (ERM); Improvement on Radiated Methods of Measurement (using test site) and evaluation of the corresponding measurement uncertainties; Part 2: Anechoic chamber".
- [i.11] ETSI TR 100 028 (all parts) (V1.4.1): "Electromagnetic compatibility and Radio spectrum Matters (ERM); Uncertainties in the measurement of mobile radio equipment characteristics".
- [i.12] ETSI EG 203 336: "Guide for the selection of technical parameters for the production of Harmonised Standards covering article 3.1(b) and article 3.2 of Directive 2014/53/EU".
- [i.13] [ERC Recommendation 74-01](#): "Unwanted emissions in the spurious domain", May 2019.
- [i.14] [ECC Report 261](#): "Short Range Devices in the frequency range 862-870 MHz".

3 Definition of terms, symbols and abbreviations

3.1 Terms

For the purposes of the present document, the following terms apply:

Adaptive Power Control (APC): mechanism to change the transmitter power in accordance with its link budget requirements

adjacent channel: frequency range equal to the width of the operating channel immediately above or immediately below the operating channel

NOTE: See Figure 1.

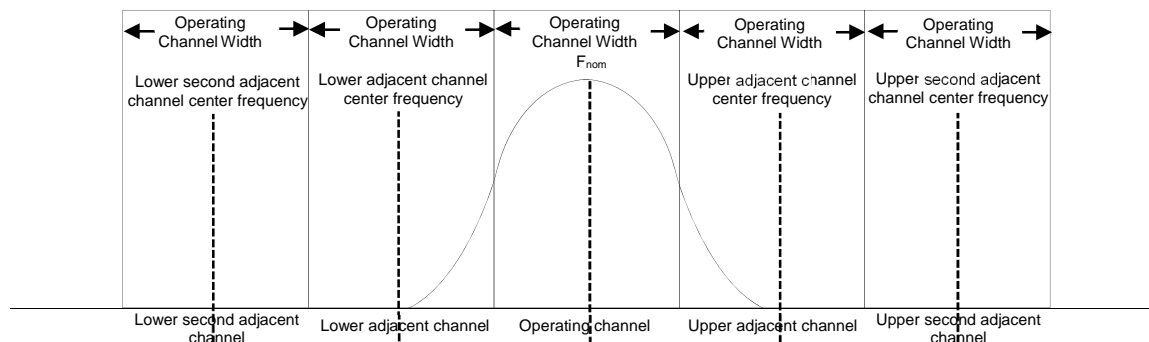

Figure 1: Adjacent and second adjacent channels definitions

adjacent channel selectivity: measure of the capability of the receiver to receive a wanted signal without exceeding a given degradation due to the presence of an unwanted signal which differs in frequency from the wanted signal by an amount equal to the OCW

blocking: measure of the capability of the receiver to receive a wanted modulated signal without exceeding a given performance criteria due to the presence of an unwanted input signal at any frequency other than those of the spurious responses frequencies or of the adjacent channels

conducted measurements: measurements which are made using a direct 50 Ω connection to the equipment under test

data network: group of wirelessly communicating SRDs composed of a network access point and one or more terminal nodes and/or network nodes

disregard time ($T_{\text{disregard}}$): interval below which two separate radio emissions in an operating channel are considered a single continuous transmitted burst

NOTE 1: See Figure 3.

NOTE 2: The value used for $T_{\text{disregard}}$ is a property of the EUT (see Annex I).

effective radiated power (e.r.p.): power radiated in the direction of the maximum field strength under specified conditions of measurement

fixed equipment: equipment intended for use in a fixed position

integral antenna: permanent fixed antenna, which may be built-in, designed as an indispensable part of the equipment

master NAP: NAP which enables the operation of nomadic and/or mobile devices

NOTE: Nomadic and mobile network nodes and nomadic and mobile terminal nodes are under the control of a master NAP in the frequency range of 915 MHz to 919,4 MHz and of 917,4 MHz to 919,4 MHz in Europe [i.4] and [i.5].

master NAP control means: means used by a master NAP to enable the operation of nomadic and/or mobile devices

mean power: power supplied to a load (e.g. antenna) averaged over an interval of time sufficiently long compared with the lowest frequency encountered in the modulation envelope

mobile equipment: equipment in operation while moving

Network Access Point (NAP): fixed terrestrial SRD connecting one or more terminal nodes and/or network nodes to an external network or service

network control information: data intended to construct or maintain a data network

network data: application data carried over a data network

Network Node (NN): SRD generating and/or consuming and/or forwarding network control information and/or network data

nomadic equipment: equipment for which the location may change but is stationary while in use

nominal operating frequency: frequency at the mid-point of the Operating Channel

observation bandwidth (F_{obs}): bandwidth in which the energy of an equipment is considered for the purposes of assessing transmission timings

observation period (T_{obs}): reference period of time

Occupied BandWidth (OBW): width of a frequency range such that, below the lower and above the upper frequency edges, the mean powers emitted are each equal to 0,5 % of the total mean power of a given emission

NOTE 1: The lower and upper frequency edges values of occupied bandwidth are denoted as $FOBW_{low}$ and $FOBW_{high}$.

NOTE 2: See Figure 2.

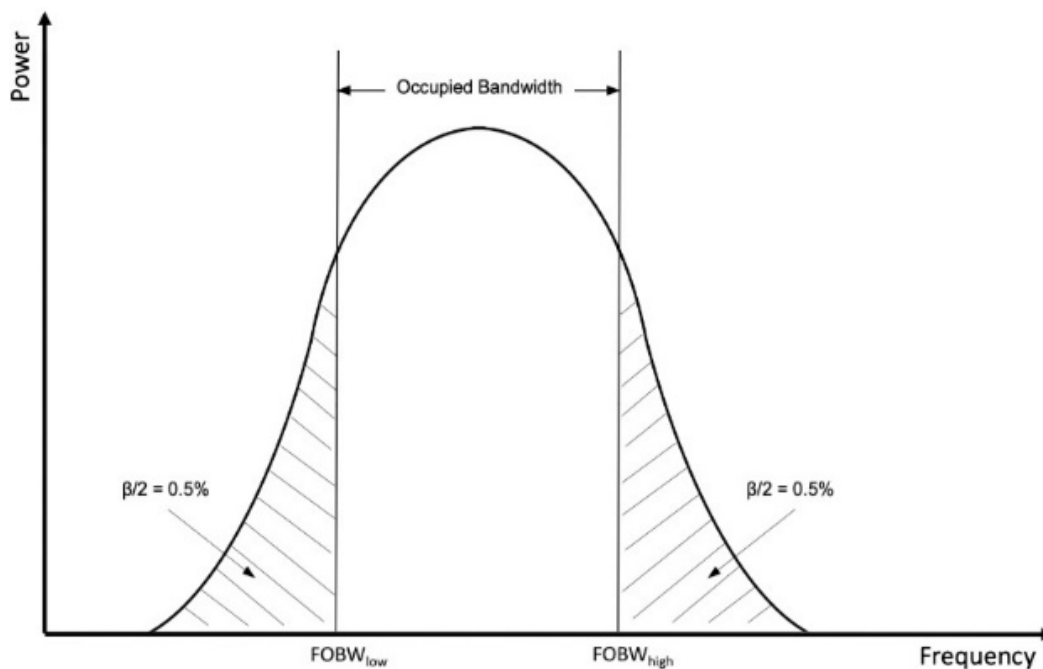

Figure 2: Emission's occupied bandwidth

Operating Channel (OC): frequency range in which the transmission or the reception occurs

NOTE: The lower and the upper frequency edges values of OC are denoted as FOC_{low} and FOC_{high} .

Operating Channel Width (OCW): width between the two frequencies FOC_{low} and FOC_{high}

Permitted Frequency Band (PFB): frequency band or sub-band within which the equipment is authorized to transmit and to perform its intended function

radiated measurements: measurements which involve the absolute measurement of a radiated field

Receiver Operating Frequency Band (RxOFB): contiguous frequency range within which the equipment is authorized to receive

receiver spurious radiations: components from the receiver at any frequency, radiated by the equipment and antenna

receiver sensitivity: the minimum level of the signal at the receiver input, at the nominal operating frequency of the receiver, which produces a specified level of performance

second adjacent channel: channel offset from the operating channel by twice the operating channel width

NOTE: See Figure 1.

signal threshold ($P_{\text{Threshold}}$): power level that determines the start and the end of an emission

SRD in data networks: short range device being part of a data network

temporary antenna connector: EUT hardware design providing connector mounting option (e.g. landing pads on PCB)

NOTE: The connector is either a standardized coaxial or a hollow waveguide connector and the necessary information how to install the connector should be in the technical documentation of the EUT.

Terminal Node (TN): SRD generating (e.g. sensor) and/or consuming (e.g. actuator) network data

transient power: power falling into the frequencies other than the operating channel due to switching the transmitter on or off

transmission: continuous radio emission, or sequence of emissions each separated by an interval shorter than $T_{\text{disregard}}$, with a signal level greater than the signal threshold $P_{\text{threshold}}$ in the operating channel

NOTE: See Figure 3.

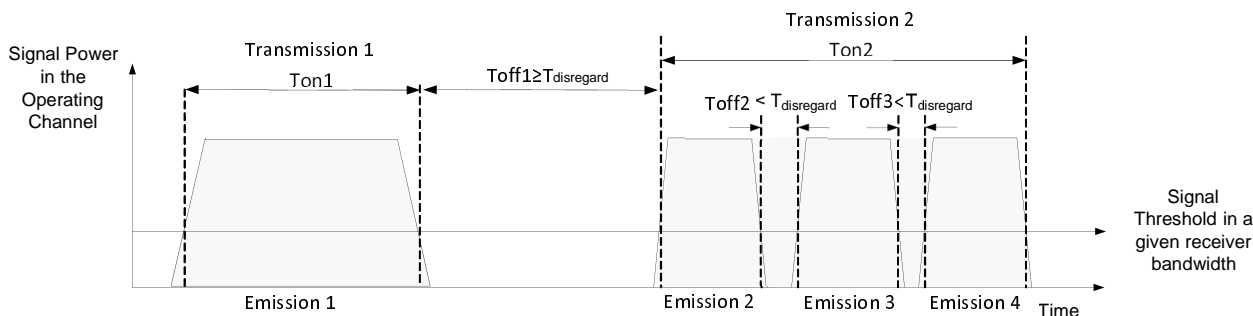

Figure 3: Illustration of two different type of transmissions

Transmitter Operating Frequency Band (TxOFB): contiguous frequency range within which the equipment is authorized to transmit

NOTE: TxOFB may be a subset of the PFB.

transmitter out-of-band domain: frequency range from $Tx\text{FOC}_{\text{low}} - 200\%$ of the OCW to $Tx\text{FOC}_{\text{low}}$ and from $Tx\text{FOC}_{\text{high}}$ to $Tx\text{FOC}_{\text{high}} + 200\%$ of the OCW

transmitter spurious domain: frequency range outside the operating channel and its out-of-band domain

unwanted emission: emission on a frequency or frequencies immediately outside the operating channel

3.2 Symbols

For the purposes of the present document, the following symbols apply:

°	degree
dB	decibel
dBc	decibel relative to peak carrier power
dBm	decibel relative to one milliwatt
f	frequency
Fobs	observation bandwidth
Ω	ohm
R	equipment data rate
S	Sensitivity of the receiver

T_{obs}	observation period of time
T_{off}	Transmitter off time
T_{on}	Transmitter on time

3.3 Abbreviations

For the purposes of the present document, the following abbreviations apply:

ACP	Adjacent Channel Power
APC	Adaptive Power Control
BER	Bit Error Ratio
BW	BandWidth
CF	Centre Frequency of the occupied bandwidth
CF_{high}	Highest Centre Frequency of measured OBW over environmental profile
CF_{low}	Lowest Centre Frequency of measured OBW over environmental profile
CISPR	International special committee on radio interference
e.r.p.	effective radiated power
EUT	Equipment Under Test
FAR	Fully Anechoic Room
PFB_{high}	Permitted Frequency Band upper edge
PFB_{low}	Permitted Frequency Band lower edge
F_{nom}	Nominal operating frequency
$F_{\text{nom Rx}}$	Nominal operating frequency Receiver part
$F_{\text{nom Tx}}$	Nominal operating frequency Transmitter part
$FOBW_{\text{high}}$	Frequency OBW upper edge
$FOBW_{\text{low}}$	Frequency OBW lower edge
FOC_{high}	Frequency Operating Channel upper edge
FOC_{low}	Frequency Operating Channel lower edge
Hz	Hertz
ITU-T	International Telecommunication Union - Telecommunication Standardization Sector
kbps	kilobits per second
kHz	kilo Hertz
LPDA	Logarithmic Periodic Dipole Antenna
Max	Maximum
MSR	Message Success Ratio
MHz	Mega Hertz
Min	Minimum
NAP	Network Access Point
NN	Network Node
NRI	National Radio Interface
OATS	Open Area Test Site
OBW	Occupied BandWidth
OC	Operating Channel
OCW	Operating Channel Width
OFDM	Orthogonal Frequency-Division Multiplexing
OFB	Operating Frequency Band
OFB_{high}	Upper Frequency of an Operating Frequency Band
OFB_{low}	Lower Frequency of an Operating Frequency Band
PFB	Permitted Frequency Band
RBW	Resolution BandWidth
RBW_{measured}	Resolution BandWidth of the measuring receiver
RBW_{REF}	Reference Resolution BandWidth
Rx	Receiver
$RxOFB$	Receiver Operating Frequency Band
SAR	Semi Anechoic Room
SRD	Short Range Device
TN	Terminal Node
Tx	Transmitter
$TxOFB$	Transmitter Operating Frequency Band
VSWR	Voltage Standing Wave Ratio

4 Technical requirements specifications

4.1 Environmental profile

The technical requirements of the present document apply under the environmental profile for operation of the equipment, which shall be in accordance with its intended use. The equipment shall comply with all the technical requirements of the present document at all times when operating within the boundary limits of the operational environmental profile defined by its intended use.

4.2 General conditions for operating

4.2.1 Wanted performance criteria

For the purpose of the receiver performance tests, the Bit Error Ratio (BER) of the receiver shall be 10^{-3} after demodulation.

NOTE: The BER can be computed from the message success ratio (MSR) by the expression:

$$\text{MSR}=(1-p)^n$$

where p is the probability of single bit error (10^{-3}) and n the number of bits in the message.

4.2.2 Types and Operating Frequency Bands

The present document covers different types of equipment as described in Table 1.

Table 1: Types

Type	Equipment function in SRD data networks	Mobility	Power (e.r.p.) mW	Notes
Type 1	NAP	Fixed	25	PFB and Transmitter Operating Frequency Bands (TxOFB) are defined in Tables E.1 and Table F.1
Type 2	NAP	Fixed	500	PFB and TxOFB are defined in Table E.1
Type 3	Master NAP	Fixed	25	PFB and TxOFB are defined in Table E.1 and Table F.1
Type 4	Master NAP	Fixed	500	PFB and TxOFB are defined in Table E.1
Type 5	NN	Fixed	25	PFB and TxOFB are defined in Table E.1 and Table F.1
Type 6	NN	Fixed	500	PFB and TxOFB are defined in Table E.1
Type 7	NN	Mobile/nomadic	25	PFB and TxOFB are defined in Table E.1 and Table F.1
Type 8	NN	Mobile/nomadic	500	PFB and TxOFB are defined in Table E.1
Type 9	NN	Mobile/nomadic	500	PFB and TxOFB are defined in Table E.1 and Table F.1
Type 10	TN	Fixed	25	PFB and TxOFB are defined in Table E.1
Type 11	TN	Fixed	500	PFB and TxOFB are defined in Table E.1
Type 12	TN	Mobile/nomadic	25	PFB and TxOFB are defined in Table E.1
Type 13	TN	Mobile/nomadic	500	PFB and TxOFB are defined in Table E.1
Type 14	TN	Mobile/nomadic	500	PFB and TxOFB are defined in Table E.1
NOTE 1: Type 8 and type 9 are operated in different PFB.				
NOTE 2: Type 13 and type 14 are operated in different PFB.				

The Receiver Operating Frequency Bands (RxOFB) given in Table 2 are available for the Rx part for each of the types given in Table 1.

Table 2: Receiver Operating Frequency Bands (RxOFB)

Type	Rx operating frequency band
Any type	865,0 MHz to 868,0 MHz
Any type	917,3 MHz to 918,9 MHz
Any type	917,4 MHz to 919,4 MHz
Any type	915 MHz to 919,4 MHz

NOTE: Short Range Devices (SRD) in data networks may use different TxOFB and RxOFB.

4.2.3 Operating conditions

The transmitter nominal operating frequency ($F_{\text{nom Tx}}$), if any, shall lie within one of the Transmitter Operating Frequency Bands (TxOFB) given in Table E.1 or in Table F.1.

The receiver nominal operating frequency ($F_{\text{nom Rx}}$), if any, shall lie within one of the Rx operating frequency bands given in Table 2.

The Operating Channel(s) (OC) shall be such that:

- They lie entirely within the OFB.
- Operating channels of the Tx part do not overlap.
- Operating channels of the Rx part do not overlap.
- The Nominal Operating Frequency (F_{nom}) is the mid-point of the OC.

Operating conditions shall be as given in Table 3.

Table 3: Equipment Operating conditions

Parameter	Value
Operating Channel lower edge frequency	$FOC_{\text{low}} \geq OFB_{\text{low}}$
Operating Channel upper edge frequency	$FOC_{\text{high}} \leq OFB_{\text{high}}$
Operating Channel Width	$OCW = FOC_{\text{high}} - FOC_{\text{low}}$
Nominal Operating Frequency	$F_{\text{nom}} = FOC_{\text{low}} + \frac{OCW}{2}$
Operating channels edges of equipment using more than one channel	$FOC_{\text{high}}(n) \leq FOC_{\text{low}}(n+1)$ for any operating channels of the Tx part or the Rx part respectively. See note 1
NOTE 1: $FOC_{\text{high}}(n)$ and $FOC_{\text{low}}(n+1)$ represent two consecutive operating channels edges numbered as n and $n+1$ of the Tx part or $FOC_{\text{high}}(n)$ and $FOC_{\text{low}}(n+1)$ represent two consecutive operating channels edges numbered as n and $n+1$ of the Rx part.	
NOTE 2: When different operating channels are specified for the transmitter part and for the receiver part, the OCW shall be calculated for each part.	
NOTE 3: The operating channel edges and the nominal operating frequency are part of the property of the equipment (see Annex I).	
NOTE 4: Annex H provides guidance relating to the operating channels.	

4.3 All equipment conformance requirements

4.3.1 Unwanted emissions in the spurious domain

4.3.1.1 Applicability

The unwanted emissions in the spurious domain requirement shall apply to all equipment.

4.3.1.2 Description

4.3.1.2.1 Spectrum mask in the transmitter spurious domain

The transmitter spurious domain is the frequency range outside the frequency interval $FOC_{low} - 200\%$ of the OCW ($F_{nom} - 2,5 \times OCW$) to $FOC_{high} + 200\%$ of the OCW ($F_{nom} + 2,5 \times OCW$).

The transmitter spurious domain is shown in Figure 4.

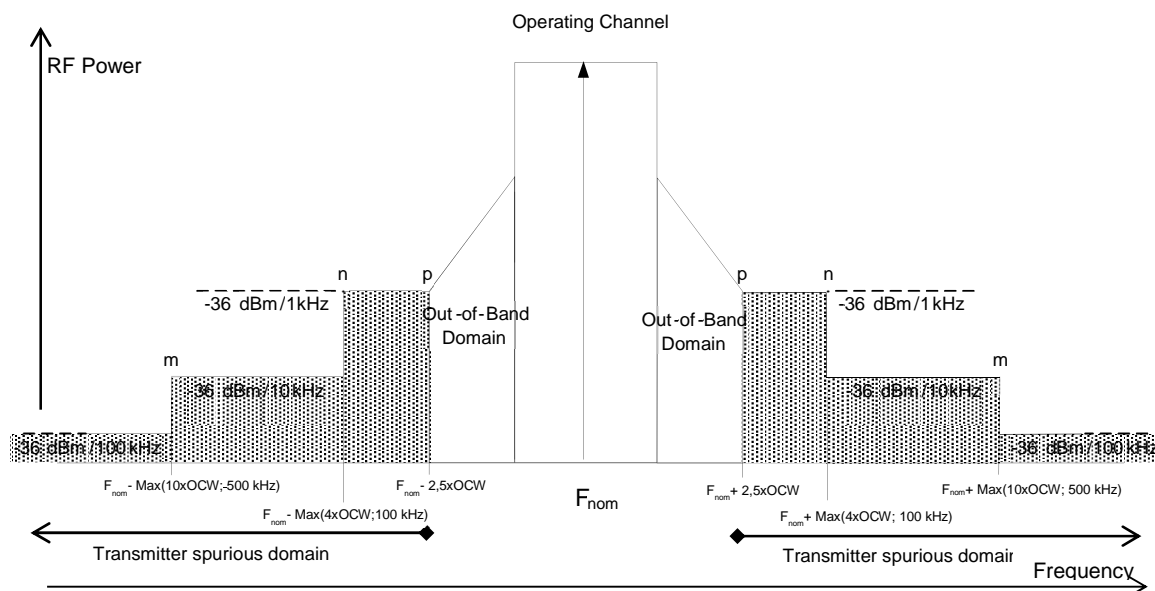

Figure 4: Spectrum mask in the transmitter spurious domain limits with reference BW

NOTE: Annex K provides examples of transmission mask considering the requirements described in clauses 4.3.1.2.1, 4.4.6 and 4.4.8.

4.3.1.2.2 Unwanted emissions for all other modes

Spurious radiations from the equipment are components, at any frequency, radiated by equipment and antenna.

4.3.1.3 Limits

The mean power of any unwanted emission in the spurious domain shall not exceed the values given in Table 4.

Table 4: Spurious domain emission limits

Frequency	87,5 MHz to 118 MHz 174 MHz to 230 MHz 470 MHz to 694 MHz	Other frequencies below 1 000 MHz	Frequencies above 1 000 MHz
State			
Spectrum mask in the transmitter spurious domain	-54 dBm	-36 dBm	-30 dBm
Rx and all other modes	-57 dBm	-57 dBm	-47 dBm

NOTE: The source of Table 4 values is ERC Recommendation 74-01 [i.13], Annex 2, Table 6.

4.3.1.4 Conformance

The conformance test suite for the unwanted emission in the spurious domain shall be as defined in clause 5.3 of the present document.

4.4 Transmitter conformance requirements

4.4.1 Effective radiated power

4.4.1.1 Applicability

The effective radiated power requirement shall apply to all transmitters.

4.4.1.2 Description

The effective radiated power (e.r.p.) is the power radiated in the direction of the maximum field strength under specified conditions of measurements for any condition of modulation.

4.4.1.3 Limits

The measured effective radiated power shall not exceed the maximum radiated power limit given in Table 5.

Table 5: Effective Radiated Power limits

Equipment type	Maximum radiated power
Type 2, type 4, type 6, type 8, type 9, type 11, type 13 and type 14	500 mW e.r.p.
Type 1, type 3, type 5, type 7, type 10 and type 12	25 mW e.r.p.

4.4.1.4 Conformance

The conformance test suite for the effective radiated power requirement shall be as defined in clause 5.4.1 of the present document.

4.4.2 Maximum occupied bandwidth

4.4.2.1 Applicability

The maximum occupied bandwidth requirement shall apply to all transmitters.

4.4.2.2 Description

The definition of the occupied bandwidth is provided in clause 3.1.

4.4.2.3 Limits

The highest occupied bandwidth value over the environmental profile shall not exceed the maximum occupied bandwidth limits specified in Table 6 depending on the type of equipment.

Table 6: Maximum occupied bandwidth limits

Equipment type	Limit
Type 2, type 4, type 6, type 8, type 9 and type 11, type 13 and type 14	200 kHz
Type 1, type 3, type 5, type 7, type 10, type 12	600 kHz

4.4.2.4 Conformance

The conformance test suite for the occupied bandwidth requirement shall be as defined in clause 5.4.2 of the present document.

4.4.3 Frequency Error

4.4.3.1 Applicability

The frequency error requirement applies to all transmitters.

4.4.3.2 Description

Frequency error requirement is specified as the error relative to the nominal operating frequency where the system operates over the intended environmental profile.

4.4.3.3 Limits

The frequency error shall not exceed the limit specified in Table 7.

Table 7: Frequency error limits

Transmitter Operating Frequency Bands	Frequency Error limit
As specified in Table 1	± 30 ppm

Where the frequency error is the difference between the measured operating frequency and the nominal operating frequency.

4.4.3.4 Conformance

The conformance test suite for the transmitter frequency error requirement shall be as defined in clause 5.4.3.

4.4.4 Transmitter Signal at the edges of the Transmitter Operating Frequency Band

4.4.4.1 Applicability

Tx signal at the edges of the TxOFB requirement shall apply to all transmitters.

4.4.4.2 Description

Tx signal at the edges of the TxOFB requirement reflects the ability of the radio transmitter to reside within the TxOFB over the intended environmental profile.

4.4.4.3 Limits

The transmission signal at any operating frequency(ies) shall reside entirely within the operating channel(s), limits as specified in Table 8.

Table 8: Tx signal at the edges of the TxOFB

Limits at any operating frequency	
$FOC_{low} \leq \text{Min FOBW}_{low}$	
$\text{Max FOBW}_{high} \leq FOC_{high}$	
With:	
<ul style="list-style-type: none"> • FOC_{low}: operating channel lower frequency edge. • FOC_{high}: operating channel upper frequency edge. • Min FOBW_{low}: lowest lower frequency edge of OBW over the intended environmental profile. • Max FOBW_{high}: highest upper frequency edge of OBW over the intended environmental profile. • OCW, FOC_{low}, FOC_{high} as specified in clause 4.2.3. 	

4.4.4.4 Conformance

The conformance test suite for the Tx signal at the edges of the TxOFB requirement shall be as defined in clause 5.4.4.

4.4.5 Transient power

4.4.5.1 Applicability

The transient power requirement shall apply to all transmitters.

4.4.5.2 Description

The transmitter transient power is power falling into frequencies other than the operating channel as a result of the transmitter being switched on and off.

4.4.5.3 Reference limits

The transient power shall not exceed the values given in Table 9.

Table 9: Transmitter Transient Power limits

Absolute offset from nominal operating frequency	RBW_{REF}	Peak power limit applicable at measurement points
< 400 kHz	1 kHz	0 dBm
≥ 400 kHz	1 kHz	-27 dBm

4.4.5.4 Conformance

The conformance test suite for the transient power requirement shall be as defined in clause 5.4.5.

4.4.6 Spectrum mask in the transmitter out-of-band domain

4.4.6.1 Applicability

The spectrum mask in the transmitter out-of-band domain requirement shall apply to all transmitters with $OCW > 25$ kHz.

NOTE: For equipment with $OCW \leq 25$ kHz, see clause 4.4.7.

4.4.6.2 Description

The definition of the transmitter out-of-band domain is given in clause 3.1.

The spectrum mask in the transmitter out-of-band domain is shown in Figure 5.

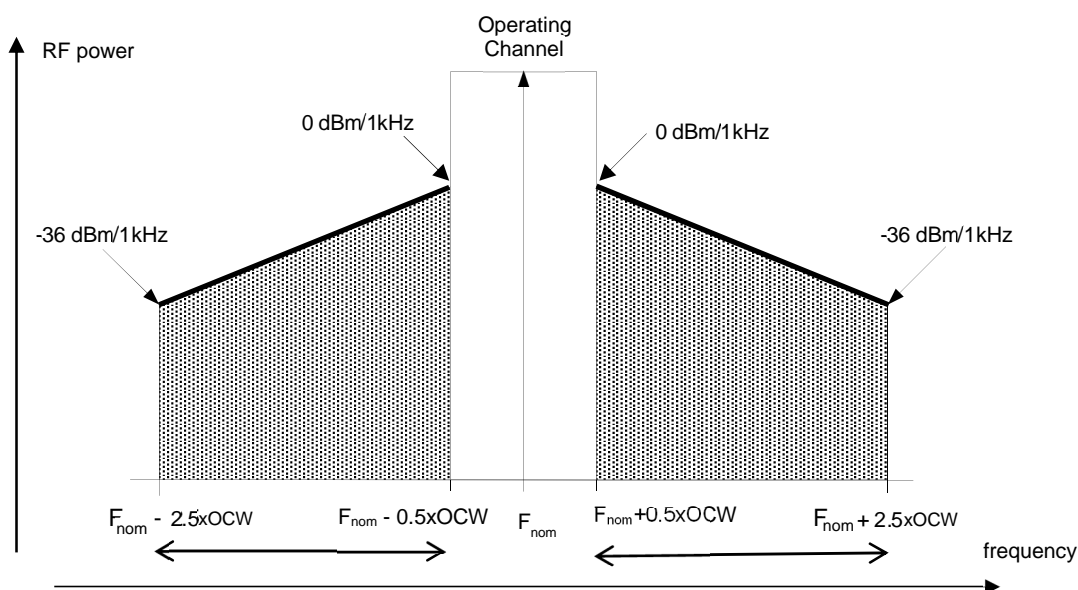

Figure 5: Transmitter out-of-band domain limits with reference BW

NOTE: Annex K provides examples of transmission mask considering the requirements given in clauses 4.3.1.2.1, 4.4.6 and 4.4.8.

4.4.6.3 Limits

The measured power within the lower and upper frequency ranges specified in Table 10 shall not exceed the corresponding power limits given in Table 10.

Table 10: Emission limits in the transmitter out-of-band domain

Frequency Range	Maximum power limit	RBW _{REF}
$f = F_{nom} - 2,5 \times OCW$	-36 dBm	1 kHz
$F_{nom} - 2,5 \times OCW \leq f \leq F_{nom} - 0,5 \times OCW$	$36 \times (f - F_{nom} + 0,5 \times OCW) / (2 \times OCW)$ dBm	1 kHz
$f = F_{nom} - 0,5 \times OCW$	0 dBm	1 kHz
$f = F_{nom} + 0,5 \times OCW$	0 dBm	1 kHz
$F_{nom} + 0,5 \times OCW \leq f \leq F_{nom} + 2,5 \times OCW$	$-36 \times (f - F_{nom} - 0,5 \times OCW) / (2 \times OCW)$ dBm	1 kHz
$f = F_{nom} + 2,5 \times OCW$	-36 dBm	1 kHz

NOTE: f , F_{nom} and OCW have to be expressed in the same unit:
 F_{nom} is the nominal operating frequency.
 OCW is the Operating Channel Width as defined in clause 4.2.3.

4.4.6.4 Conformance

The conformance test suite for the spectrum mask in the transmitter out-of-band domain requirement shall be as defined in clause 5.4.6 of the present document.

4.4.7 Adjacent Channel Power

4.4.7.1 Applicability

Adjacent channel power requirement shall apply to all transmitters with $OCW \leq 25$ kHz.

NOTE: For equipment with $OCW > 25$ kHz, see clause 4.4.6.

4.4.7.2 Description

Adjacent channel power is power incidental to proper operation of a transmitter falling into the adjacent and second adjacent channels.

4.4.7.3 Limits

The power in each adjacent channel and each second adjacent channel shall not exceed the values given in Table 11.

Table 11: Adjacent channel power limits for transmitters with OCW \leq 25 kHz

Adjacent channel power integrated over $0,7 \times \text{OCW}$	Second adjacent channel power integrated over $0,7 \times \text{OCW}$
-15 dBm	-24 dBm

4.4.7.4 Conformance

The conformance test suite for adjacent channel power requirement shall be as defined in clause 5.4.7.

4.4.8 Spectrum mask at permitted frequency band edges

4.4.8.1 Applicability

The spectrum mask at permitted frequency band edges requirement shall apply to all transmitters.

4.4.8.2 Description

Specific limits apply at frequencies immediately above and below the permitted frequency band edges as defined in Table E.1 and Table F.1. The limits are illustrated in Figure 6.

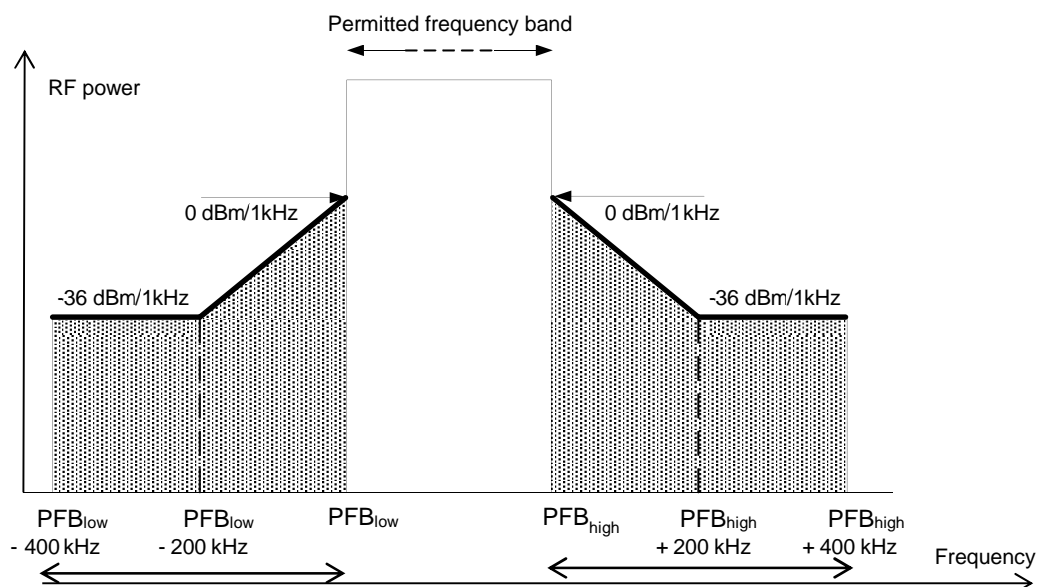

Figure 6: Spectrum mask at permitted frequency band edges with reference BW

NOTE 1: PFB_{low} is the lower edge of the permitted frequency band (see Annex E and Annex F).

PFB_{high} is the upper edge of the permitted frequency band (see Annex E and Annex F).

NOTE 2: Annex K provides examples of transmission mask considering the requirements given in clauses 4.3.1.2.1, 4.4.6 and 4.4.8.

4.4.8.3 Limits

The equipment emissions level shall be less or equal to the maximum power limit given in the reference bandwidth (RBW_{REF}) depending on the frequency range given in Table 12.

Table 12: Emission limits at the permitted frequency band edges

Frequency Range (MHz)	Maximum power limit (dBm)	RBW_{REF}
$PFB_{low} - 0,4 \leq f \leq PFB_{low} - 0,2$	-36	1 kHz
$PFB_{low} - 0,2 \leq f < PFB_{low}$	$180 \times (f - PFB_{low})$	1 kHz
$f = PFB_{low}$	0	1 kHz
$f = PFB_{high}$	0	1 kHz
$PFB_{high} < f \leq PFB_{high} + 0,2$	$-180 \times (f - PFB_{high})$	1 kHz
$PFB_{high} + 0,2 \leq f \leq PFB_{high} + 0,4$	-36	1 kHz

NOTE: f is the frequency in MHz.
PFB depending on the type are given in Annex E and Annex F.
 PFB_{low} is the lower edge of the permitted frequency band in MHz.
 PFB_{high} is the upper edge of the permitted frequency band in MHz.

4.4.8.4 Conformance

The conformance test suite for transmitter spectrum mask at permitted frequency band edges requirement shall be as defined in clause 5.4.8.

4.4.9 Duty Cycle

4.4.9.1 Applicability

The duty cycle requirement shall apply to all transmitters.

4.4.9.2 Description

Duty cycle is the ratio expressed as a percentage, of the cumulative duration of transmissions T_{on_cum} within an observation period T_{obs} $DC = \left(\frac{T_{on_cum}}{T_{obs}} \right)_{F_{obs}}$ on an observation bandwidth F_{obs} .

Unless otherwise specified, T_{obs} is 1 hour and the observation bandwidth F_{obs} is the permitted frequency band given in Table 1 in which the Tx nominal operating frequency lies. Each transmission consists of an RF emission, or sequence of RF emissions separated by intervals $< T_{disregard}$.

An equipment may operate on more than one permitted frequency bands simultaneously (i.e. multi transmissions), Duty Cycle limit of each individual band applies to each transmission within that band.

In case of a multicarrier modulation in a band, the duty cycle applies to the whole signal used for a transmission (e.g. OFDM).

Equipment may be triggered manually, by internal timing or by external stimulus. Depending on the method of triggering the timing may be predictable or random.

4.4.9.3 Limit

The measured duty cycle shall not exceed the limits defined in Table 13.

Table 13: Duty cycle limits

Equipment type	Duty cycle limit
Type 11, type 13, type 14	0,25 % (see note)
Type 1, type 3, type 5, type 7, type 10, type 12	1 %
Type 6, type 8, type 9	2,5 %
Type 2, type 4	10 %
NOTE: Terminal Node limit is set to a value representative of average TN activity of 0,1 % assumed in ECC Report 261 [i.14].	

4.4.9.4 Conformance

The conformance test for the duty cycle requirement shall be as defined in clause 5.4.9.

4.4.10 Adaptive power control

4.4.10.1 Applicability

The automatic/adaptive power control requirement shall apply to type 2, type 4, type 6, type 8, type 9, type 11, type 13 and type 14 transmitters.

4.4.10.2 Description

Adaptive Power Control (APC) is the capability that automatically enables the transmitter output power of an equipment to be adjusted during operation in accordance with its link budget requirements or other conditions. It modifies the power transmitted by the equipment when communicating with a companion equipment. APC requires bi-directional communications to exchange information used to manage the transmitted power level. Such information exchange is out of scope of the present document.

4.4.10.3 Limits

The peak measured power shall not exceed the value shown in Table 14.

Table 14: APC power limit

Parameter	Limit
Transmitted Power	+7 dBm / 5 mW

4.4.10.4 Conformance

The conformance test suite for the adaptive power control requirement shall be as defined in clause 5.4.10.

4.4.11 Transmitter behaviour under low-voltage conditions

4.4.11.1 Applicability

The transmitter behaviour under low-voltage conditions requirement shall apply to battery powered transmitters.

4.4.11.2 Description

The transmitter behaviour under low voltage conditions is the ability of the equipment to remain within the transmitter operating frequency ranges as defined in Table 1 and not produce emissions which exceed the limit given in clause 4.4.11.3 when the battery voltage falls below the lowest voltage from the environmental profile.

4.4.11.3 Limits

The equipment shall either:

- a) remain in the transmitter operating frequency bands defined in Table 1 without exceeding the duty cycle limits given in clause 4.4.9; or
- b) reduce its effective radiated power below the limits in the transmitter spurious domain given in clause 4.3.1; or
- c) shut down, (ceasing function);

as the voltage falls below the lowest voltage from the environmental profile.

4.4.11.4 Conformance

The conformance test suite for the frequency stability under low-voltage conditions requirement shall be as defined in clause 5.4.11.

4.5 Receiver conformance requirements

4.5.1 Receiver sensitivity

4.5.1.1 Applicability

The receiver sensitivity requirement shall apply to all receivers.

4.5.1.2 Description

Receiver sensitivity is the minimum signal power input to the receiver which produces the wanted performance criteria stated in clause 4.2.1 of the present document.

4.5.1.3 Limits

The measured receiver sensitivity shall not be higher than the limits given in Table 15.

Table 15: Limits for receiver sensitivity

Parameter	Limit
Receiver sensitivity	-91 dBm
NOTE: The receiver sensitivity is based on a 50 kbps data rate. For other rates the sensitivity shall be adjusted according to the following formula: $S = 10 \log_{10} \left(\frac{R}{50} \right) - 91 \text{ dBm}$ where: <ul style="list-style-type: none"> – S is the sensitivity in dBm; – R is the equipment data rate in kbps. 	

4.5.1.4 Conformance

The conformance test suite for the receiver sensitivity requirement shall be as defined in clause 5.5.1.

4.5.2 Adjacent channel selectivity

4.5.2.1 Applicability

The receiver adjacent channel selectivity requirement shall apply to all receivers.

4.5.2.2 Description

The adjacent channel selectivity is a measure of the receiver capability to receive a wanted signal without exceeding the wanted performance criteria stated in clause 4.2.1 of the present document due to the presence of an unwanted input signal in the adjacent channels.

4.5.2.3 Limits

The measured adjacent channel selectivity shall not be less than the value specified in Table 16.

Table 16: Adjacent channel selectivity limit

Parameter	Value	
	Wanted signal = S + 3 dB	Wanted signal = S + 23 dB
Adjacent channel selectivity	-61 dBm	-41 dBm

4.5.2.4 Conformance

The conformance test suite for the adjacent channel selectivity requirement shall be as defined in clause 5.5.2 of the present document.

4.5.3 Spurious response rejection

4.5.3.1 Applicability

The spurious response rejection requirement shall apply to all receivers.

4.5.3.2 Description

The spurious response rejection requirement is a measure of the capability of the receiver to receive a wanted signal without exceeding the wanted performance criteria stated in clause 4.2.1 of the present document due to the presence of an unwanted signal at any frequency at which a response is obtained.

4.5.3.3 Limits

The measured receiver rejection level for any spurious response shall not be less than the limits given in Table 17.

Table 17: Receiver spurious response rejection limits

Frequency range	Limit
$FOC_{high} \leq f < FOC_{high} + 1 \text{ MHz}$ $FOC_{low} - 1 \text{ MHz} < f \leq FOC_{low}$	-70 dBm
$FOC_{high} + 20 \text{ MHz} \geq f \geq FOC_{high} + 1 \text{ MHz}$ $FOC_{low} - 20 \text{ MHz} f \leq FOC_{low} - 1 \text{ MHz}$	-50 dBm

4.5.3.4 Conformance

The conformance test suite for the receiver spurious response rejection requirement shall be as defined in clause 5.5.3.

4.5.4 Blocking

4.5.4.1 Applicability

The blocking requirement shall apply to all receivers.

4.5.4.2 Description

Blocking is a measure of the capability of the receiver to receive a wanted signal without exceeding the performance criteria stated in clause 4.2.1 of the present document due to the presence of an unwanted input signal at any frequencies other than those of the spurious responses or the adjacent channels.

NOTE: The adjacent channel selectivity is specified in clause 4.5.2 and the spurious response rejection is specified in clause 4.5.3.

4.5.4.3 Limits

The blocking levels at the specified frequency offsets shall be equal to or greater than the limits in Table 18.

Table 18: Limits for the blocking

Frequency offset	Limits	
	Wanted signal = S + 3 dB	Wanted signal = S + 23 dB
FOC _{high} + 1 MHz and FOC _{low} - 1 MHz	-50 dBm	-30 dBm
FOC _{high} + 2 MHz and FOC _{low} - 2 MHz	-43 dBm	-23 dBm
FOC _{high} + 5 MHz and FOC _{low} - 5 MHz	-38 dBm	-18 dBm
FOC _{high} + 10 MHz and FOC _{low} - 10 MHz	-33 dBm	-13 dBm
FOC _{high} + 15 MHz and FOC _{low} - 15 MHz	-33 dBm	-13 dBm

4.5.4.4 Conformance

The conformance test suite for the blocking requirement shall be as defined in clause 5.5.3 of the present document.

4.5.5 Receiver maximum input signal level

4.5.5.1 Applicability

The receiver dynamic range requirement shall apply to all receivers.

4.5.5.2 Description

Receiver sensitivity is the minimum signal power input to the receiver which produces the general performance criteria stated in clause 4.2.1 of the present document.

4.5.5.3 Limits

The measured maximum input signal level shall not be less than the limits given in Table 19.

Table 19: Limits for receiver maximum input signal level

Parameter	Limit
Rx maximum input signal level	-19 dBm+10 x og (OCW / 200)
NOTE 1: The OCW is defined in kHz.	
NOTE 2: The OCW is determined for the Rx part when different from the Tx part.	

4.5.5.4 Conformance

The conformance test suite for the receiver dynamic range requirement shall be as defined in clause 5.5.4.

4.6 Functional requirements

4.6.1 Network Access Point

4.6.1.1 Applicability

The Network Access Point (NAP) requirement shall apply to equipment type 1, type 2, type 3 and type 4.

4.6.1.2 Description

Equipment type 1, type 2, type 3 and type 4 equipment shall provide a means for terminal nodes and/or network nodes in a data network to communicate with a network or service outside the data network.

Messages to be transferred via the NAP may originate within or outside the data network. Once received by the NAP, such messages shall be transferred to the intended destination.

The delay between the message transfer request received by the NAP and the transfer of the message by the NAP to its intended destination is the NAP message transit delay.

NOTE: The mechanisms used to transfer the messages are outside the scope of the present document. For example, messages may be re-transmitted as received, may be transformed into different protocol encapsulations or may be translated in any manner required by the equipment under test, and may be transmitted reliably or unreliably.

4.6.1.3 Limits

The NAP message transit delay shall not exceed the value specified in Table 20.

Table 20: Network access point limits

Parameter	Time value
NAP message transit delay	60 minutes

4.6.1.4 Conformance

The conformance test suite for the Network Access Point requirement shall be as defined in clause 5.6.2.

4.6.2 Under the control of a Master NAP

4.6.2.1 Applicability

The under the control of a master NAP requirement shall apply to equipment type 7, type 9, type 12 and type 14.

4.6.2.2 Description

Equipment type 7, type 9, type 12 and type 14 stop transmitting if they are not receiving a message from a master NAP. Since the devices may have received previously a message from the NAP allowing them to transmit the limit applies after a period of one hour.

4.6.2.3 Limits

Table 21 provides the limit on the number of transmissions.

Table 21: Under the control of a Master NAP limit

Parameter	Value
Number of transmissions after one hour without Master NAP	0

4.6.2.4 Conformance

The conformance test suite for the Master NAP requirement shall be as defined in clause 5.6.3.

4.6.3 Master NAP

4.6.3.1 Applicability

The Master NAP requirement shall apply to equipment type 3 and type 4.

4.6.3.2 Description

Equipment type 3 and type 4 shall ensure that mobile or nomadic terminal nodes or as well as mobile or nomadic network nodes can detect that they are within the coverage of a Master NAP.

4.6.3.3 Limits

In the absence of a master NAP, mobile or nomadic terminal nodes or mobile or nomadic network nodes shall stop transmitting. Limit is defined in clause 4.6.2.3.

4.6.3.4 Conformance

The conformance test suite for the Master NAP requirement shall be as defined in clause 5.6.4.

5 Testing for compliance with technical requirements

5.1 Environmental conditions for testing

5.1.1 General considerations

Tests defined in the present document shall be carried out at representative points within the boundary limits of the operational environmental profile defined by its intended use.

Where technical performance varies subject to environmental conditions, tests shall be carried out under a sufficient variety of environmental conditions (within the boundary limits of the operational environmental profile defined by its intended use) to give confidence of compliance for the affected technical requirements.

5.1.2 Normal test conditions

5.1.2.1 Normal temperature and humidity for the tests

The normal temperature and humidity conditions for the test shall be within the following ranges:

- temperature +15 °C to +30 °C
- relative humidity 20 % to 75 %.

5.1.2.2 Normal power source for the tests

5.1.2.2.1 Mains voltage

The normal voltage for equipment to be connected to the mains shall be the nominal intended mains voltage (see Annex I).

The frequency of the power source corresponding to the AC mains shall be between 49 Hz and 51 Hz.

5.1.2.2.2 Battery power sources

When the radio equipment is intended for operation with a battery, the normal test voltage is the equipment nominal voltage as provided by Annex I.

5.1.3 Extreme conditions for the tests

5.1.3.1 Extreme temperatures range

The upper and lower temperatures of one of the following ranges, either:

- temperature category I (indoor and outdoor): -20 °C to +55 °C;
- temperature category II (indoor only): +5 °C to +35 °C.

The test report shall state which corresponding thermal range is used.

In case the upper temperature of the environmental profile given by the intended use (given in Annex I) is higher than the higher temperature defined in the temperatures range, the test shall be extended up to the upper temperature of the environmental profile given by the intended use.

In case the lower temperature of the environmental profile given by the intended use (given in Annex I) is lower than the lower temperature defined in the temperatures range, the test shall be extended down to the lower temperature of the environmental profile given by the intended use.

5.1.3.2 Extreme test source voltage

5.1.3.2.1 Mains voltage

The extreme test voltages for equipment to be connected to an AC mains source shall be the nominal mains voltage $\pm 10\%$.

5.1.3.2.2 Lead-acid battery power sources

When the radio equipment is designed for operation using lead-acid battery power source the extreme voltages shall be 1,3 (for the maximum voltage) and 0,9 (for the minimum voltage) multiplied by the battery nominal voltage (6 V, 12 V, etc.) which is provided by Annex I.

For "gel-cell" type batteries the extreme voltage shall be 1,15 (for the maximum voltage) and 0,85 (for the minimum voltage) multiplied by the battery nominal voltage, which is provided by Annex I.

5.1.3.2.3 Other power sources

For operation from other power sources or types of battery, the extreme test voltage is given by the intended use as provided by Annex I.

5.1.3.3 Test conditions

The tests shall be performed according to Table 22.

Table 22: Test conditions

Clause	Requirement	Test conditions
5.3.1	Unwanted emissions in the spurious domain	Normal
5.4.1	Effective radiated power	Extreme
5.4.2	Maximum occupied bandwidth	Extreme
5.4.3	Frequency error	Extreme
5.4.4	Transmitter signal at the edges of the TxOFB	Extreme
5.4.5	Transient power	Normal
5.4.6	Spectrum mask in the transmitter out-of-band domain	Extreme
5.4.7	Adjacent channel power	Normal
5.4.8	Transmitter spectrum mask at the permitted frequency band edges	Extreme
5.4.9	Duty cycle	Normal
5.4.10	Adaptative power control	Normal
5.4.11	Transmitter behaviour under Low Voltage Conditions	Normal
5.5.1	Receiver sensitivity	Extreme
5.5.2	Adjacent channel selectivity	Normal
5.5.3	Blocking and spurious response rejection	Normal
5.5.4	Receiver maximum input signal level	Normal
5.6.2	Network access point	Normal
5.6.3	Under the control of a master NAP	Normal
5.6.4	Master NAP	Normal

5.2 General considerations for testing

5.2.0 General considerations

Technical documentation and operating manuals, to allow testing to be performed, shall be provided along with the EUT and any companion equipment necessary for the EUT intended use. Annex I identifies various EUT properties required by the test suites specified in the present document.

For devices having several nominal operating frequencies but identical OCW, measurements shall be performed on the lowest and the highest nominal operating frequencies (see Annex I) in a given permitted frequency band (see Table E.1 and Table F.1). This is intended to give confidence that the requirements set out in the present document have been met without the necessity of performing measurements on all frequencies.

For devices having several nominal operating frequencies with different OCW, measurements shall be performed at all operating frequencies.

5.2.1 Presentation of the EUT for testing purposes

5.2.1.1 Choice of model for testing

5.2.1.1.1 General considerations

One or more samples of the EUT, as needed, shall be tested.

All necessary test signal sources special to the equipment and set-up information shall accompany the equipment when it is submitted for testing.

5.2.1.1.2 EUT with an external RF connector

The EUT with an external RF connector offered for testing shall provide a 50 Ω connector for conducted RF power measurements.

5.2.1.1.3 EUT without an external RF connector

5.2.1.1.3.1 General Considerations

Conducted measurements on an EUT with an integral antenna or with an antenna connection other than a 50 Ω coaxial connector may be made by:

- access to an internal connector; or
- fitting of a temporary connector with addition of a 20 dB attenuator, if no internal connector is available; or
- use of a test fixture if none of above possibilities are available.

5.2.1.1.3.2 EUT with an internal connector

Where the EUT has an internal 50 Ω coaxial connector between the antenna and the circuitry, this may be utilized to perform conducted measurements.

Use of an internal antenna connection shall be recorded in the test report.

5.2.1.1.3.3 EUT with a temporary antenna connector

One EUT, with the normal antenna connected or integral antenna, shall be tested using radiated measurement procedures. For relative measurements, two EUTs may be submitted to the test laboratory, one fitted with a temporary antenna connector mounted on the Printed Circuit Board with the antenna disconnected and another with the antenna connected. The EUT with integral antenna shall be used for radiated measurements. The second EUT with the temporary connector can only be used for RF power relative measurements or other measurements not related to RF power. The two EUTs shall be identical in all respects except for the temporary antenna connector.

Use of an EUT with a temporary antenna connection shall be recorded in the test report.

5.2.1.1.3.4 Use of a Test Fixture

A test fixture is a structure for coupling an EUT with an integral antenna, at all frequencies for which measurements need to be performed, to a 50 Ω RF terminal.

A test fixture can only be used if no internal or temporary connector is available and only for relative measurements.

For further information on the test fixture, see Annex C.

5.2.2 Test power source

5.2.2.1 General considerations

The EUT shall be tested using the appropriate test power source as specified in clauses 5.2.2.2 or 5.2.2.3. Where the EUT is intended to be powered using either external or internal power sources, then the EUT shall be tested using the external power source as specified in clause 5.2.2.2, then repeated using the internal power source as specified in clause 5.2.2.3.

The test power source used shall be stated in the test report.

5.2.2.2 External test power source

External test power sources shall be capable of producing test voltages as specified in the environmental profile. The internal impedance of the external test power source shall be low enough for its effect on the test results to be negligible. For the purpose of the tests, the voltage of the external test power source shall be measured at the input terminals of the EUT. This may be the mains connection point for EUT supplied with an external power supply. The external test power source shall be de-coupled and applied immediately at the equipment battery terminals. For radiated measurements, any external power cable shall be equipped with ferrite bead which shall present an impedance of at least 100 Ω at 100 MHz according to the manufacturer's datasheet of the used ferrite.

5.2.2.3 Internal test power source

For radiated measurements on portable EUT with integral or dedicated antenna, fully charged internal batteries shall be used. The batteries used shall be as supplied or recommended by the manufacturer. If internal batteries are used, at the end of each test the voltage shall be within 5 % of the voltage at the beginning of each test. Where this is not possible, clause B.4.2 applies.

5.2.3 Thermal test conditions

Before the measurements are performed, the EUT shall have reached thermal balance in the test chamber. The EUT shall be switched off during the temperature stabilizing period.

In the case of EUT containing temperature stabilization circuits designed to operate continuously, the temperature stabilization circuits should be powered on for 15 minutes after thermal balance has been obtained, and the EUT should then meet the specified requirements.

If the thermal balance is not checked by measurements, a temperature stabilizing period of at least one hour should be allowed. The humidity content in the test chamber should be controlled so that excessive condensation does not occur.

5.2.4 Conducted measurements

Conducted tests shall be carried out using an attenuator connected to the EUT antenna connector and providing a 50 Ω output or connection to test equipment. The attenuator shall provide an attenuation of 20 dB. The attenuation value shall be added to the power measurement values.

NOTE: 20 dB attenuator protects test equipment as the maximum power will never exceed 7 dBm at its input connector.

5.2.5 Radiated measurements

For all radiated measurements a test site, selected from those described in clause B.2, following the guidance given in clause B.7, shall be used. When performing radiated transmitter measurements, the EUT shall be configured and antenna(s) positioned (including smart antenna systems and systems capable of beam forming) and oriented for maximum radiated power into the measuring antenna.

When performing radiated receiver measurements, the EUT shall be configured and antenna(s) positioned (including smart antenna systems and systems capable of beam forming) for maximum sensitivity towards the test antenna. For a transceiver EUT, the most sensitive position is the same position as where the maximum e.r.p. was measured. For receiver only EUT, the measurement test clause 5.5.1.4 shall be performed at different angles from the turntable until the lowest sensitivity level is reached which corresponds to maximum device sensitivity toward the test antenna.

5.2.6 Applicable measurement methods

Although the measurement methods in the present document allow conducted measurements to be performed, the EUT together with all its intended antenna assemblies shall comply with the applicable technical requirements.

For equipment with pulse modulation, or where it is not possible to make a required measurement in the absence of modulation, the measurement shall be carried out by the use of a measuring receiver with receiver bandwidth according to clause 5.2.8.

A summary of the applicable measurement methods for each test suite are shown in Table 23.

Table 23: Applicable test methods

Clause	Requirement	Test method		
		Radiated	Conducted	Test fixture
5.3.1	Unwanted emissions in the spurious domain	Yes	Yes	No
5.4.1	Effective radiated power	Yes	Yes	See note 1
5.4.2	Maximum occupied bandwidth	Yes	Yes	See note 1
5.4.3	Frequency error	Yes	Yes	Yes
5.4.4	Transmitter signal at the edges of the TxOFB	Yes	Yes	See note 1
5.4.5	Transient power	Yes	Yes	No
5.4.6	Spectrum mask in the transmitter out-of-band domain	Yes	Yes	No
5.4.7	Adjacent channel power	Yes	Yes	No
5.4.8	Transmitter spectrum mask at the permitted frequency band edges	Yes	Yes	No
5.4.9	Duty cycle	Yes	Yes	Yes
5.4.10	Adaptative power control	Yes	Yes	No
5.4.11	Transmitter behaviour under Low Voltage Conditions	Yes	Yes	Yes
5.5.1	Receiver sensitivity	Yes	Yes	No
5.5.2	Adjacent channel selectivity	Yes	Yes	No
5.5.3	Blocking and spurious response rejection	Yes	Yes	No
5.5.4	Receiver maximum input signal level	Yes	Yes	No
5.6.2	Network access point	Yes	Yes	Yes
5.6.3	Under the control of a master NAP	Yes	Yes	Yes
5.6.4	Master NAP	Yes	Yes	Yes
NOTE 1: Only for relative measurements for extreme temperature tests (see clause 5.1.3.1).				
NOTE 2: Absolute radiated tests are only possible under normal conditions (see clause 5.1.2). Relative radiated tests, conducted tests and test fixture can be performed for both normal and extreme conditions.				

If the EUT has more than one antenna port, e.g. separate antennas for transmitter and receiver or separate antennas for different operating frequencies or diversity antennas, then:

- If every antenna port has a 50 Ω connector, conducted measurements may be performed as in Table 23. All the antenna ports shall be terminated in 50 Ω connections as described in clause 5.2.5.
- Otherwise only radiated measurements shall be performed. All antenna ports shall be fitted with an antenna representative of normal use.

NOTE: The reason is that replacing one antenna by a transmission line may affect the operation of any other antennas.

5.2.7 Test signals

For the purposes of the present document a test signal is a modulated or unmodulated carrier generated by the EUT to facilitate a particular test. The EUT should be capable of generating the following test signals:

- D-M1: A test signal consisting of an unmodulated carrier. This test signal is optional but helps to simplify some tests.
- D-M2: A test signal consisting of a modulated carrier representative of the intended use and generating the greatest occupied RF bandwidth. The preferred test signal consists of a pseudo-random bit sequence of at least 511 bits in accordance with Recommendation ITU-T O.153 [i.6]. This sequence shall be continuously repeated.

The EUT shall be capable to generate the following test signal:

- D-M3: A test signal representative of the intended use of the EUT. The test signal may be formatted and may contain error detection and correction.

Test signals may be generated by applying test baseband signals to a modulation port on the equipment for receiver or be generated internally by the equipment for transmitter. Operation in a test mode may involve suitable temporary internal modifications of the equipment under test or the use of special software. Details of the method employed shall be recorded in the test report.

For each test performed, the test signal used shall be recorded in the test report. Permitted test signals for each test are shown in Table 24.

Table 24: Permitted test signals

Clause	Requirement with clause number	Test Signal
5.3.1	Unwanted emissions in the spurious domain	D-M1 if available otherwise, D-M2 if available, otherwise D-M3
5.4.1	Effective Radiated Power	D-M1 if available, otherwise D-M2 if available, otherwise D-M3
5.4.2	Maximum occupied bandwidth	D-M2 if available, otherwise D-M3
5.4.3	Frequency error	D-M1 if available, otherwise D-M2 if available, otherwise D-M3
5.4.4	Transmitter signal at the edges of the TxOFB	D-M2 if available, otherwise D-M3
5.4.5	Transient power	D-M3
5.4.6	Spectrum mask in the transmitter out-of-band domain	D-M2 if available, otherwise D-M3
5.4.7	Adjacent channel power	D-M2 if available, otherwise D-M3
5.4.8	Transmitter spectrum mask at the permitted frequency band edges	D-M2 if available, otherwise D-M3
5.4.9	Duty cycle	D-M3
5.4.10	Adaptive power control	D-M3
5.4.11	Transmitter behaviour under low voltage conditions	D-M2 if available, otherwise D-M3
5.5.1	Receiver sensitivity	D-M3
5.5.2	Adjacent channel selectivity	D-M3
5.5.3	Blocking and spurious response rejection	D-M3
5.5.4	Receiver maximum input signal level	D-M2 if available, otherwise D-M3
5.6.2	Network access point	D-M3
5.6.3	Under the control of a master NAP	D-M3
5.6.4	Master NAP	D-M3

5.2.8 Measuring receiver

5.2.8.1 General considerations

The term "measuring receiver" refers to a frequency-selective voltmeter or a spectrum analyser. Unless stated otherwise, an RMS detector shall be used.

5.2.8.2 Reference Bandwidth

The resolution bandwidth of the measuring receiver (RBW_{measured}) should be equal to the Reference BandWidth (RBW_{REF}) given in Table 25.

Table 25: Resolution bandwidth for the measuring receiver

Measured frequency range (f)	Measuring receiver resolution bandwidth (RBW_{REF})
$f < 150 \text{ kHz}$	200 Hz or 300 Hz
$150 \text{ kHz} \leq f < 25 \text{ MHz}$	9 kHz or 10 kHz
$25 \text{ MHz} \leq f \leq 1\,000 \text{ MHz}$	100 kHz or 120 kHz
$f > 1\,000 \text{ MHz}$	1 MHz
NOTE: The frequency ranges and corresponding RBW_{REF} values are derived from CISPR 16 [i.7].	

To extract the signal from noise floor, the test equipment (RBW_{measured}) may be different from RBW_{REF} but a correction shall be applied before to compare power levels to limits:

When $RBW_{\text{measured}} < RBW_{\text{REF}}$ the result should be integrated over RBW_{REF} according to the following formula (1):

$$B = 10 \log \left(RBW_{\text{REF}} \times \frac{\left(\frac{1}{n} \right) \times \sum_{i=1}^n \left(10^{\left(\frac{P(i)}{10} \right)} \right)}{RBW_{\text{measured}}} \right) \quad (1)$$

Where:

- $P(i)$ are the measured samples with RBW_{measured} ;
- n is the number of samples inside RBW_{REF} ;
- B is the corresponding value in the RBW_{REF} .

When $RBW_{\text{measured}} > RBW_{\text{REF}}$ the result for broadband emissions should be normalized to the bandwidth ratio according to the following formula (2):

$$B = A + 10 \log \frac{RBW_{\text{REF}}}{RBW_{\text{measured}}} \quad (2)$$

Where:

- A is the measured value in the measurement bandwidth RBW_{measured} ;
- B is the corresponding value in the reference bandwidth RBW_{REF} .

For discrete spurious emissions, defined as a narrow peak with a level of at least 6 dB above the average level inside the measurement bandwidth, normalization is not applicable, while integration over RBW_{REF} is still applicable.

5.2.9 Signal Threshold

The value used for $P_{\text{threshold}}$ in all requirements and test methods of the present document shall be -26 dBc.

5.3 All equipment conformance requirements

5.3.1 Unwanted emissions in the spurious domain

5.3.1.1 Test conditions for the spectrum mask in the transmitter spurious domain

- 1) An EUT without an external 50 Ω coaxial antenna connector, the spectrum mask in the transmitter spurious domain shall be established according to the radiated measurement procedure in clause 5.3.1.3.1.
- 2) For all other EUT, the emission levels of the spectrum mask in the transmitter spurious domain shall be established as both:
 - the radiated measurement procedure in clause 5.3.1.3.1, with the antenna port terminated in a 50 Ω non-reactive and non-radiating load (see Figure 7); and
 - the conducted measurement procedure in clause 5.3.1.3.2.
- 3) The measurement shall be performed with the EUT operating at its maximum operating power level.
- 4) The reference RBW of measuring receiver are shown in Table 26.

Table 26: Parameters for spectrum mask in the Tx spurious domain

Frequency Range	RBW _{REF} (see note 2)
$30 \text{ MHz} \leq f < F_{\text{nom}} - m$	100 kHz
$F_{\text{nom}} - m \leq f < F_{\text{nom}} - n$	10 kHz
$F_{\text{nom}} - n \leq f < F_{\text{nom}} - p$	1 kHz
$F_{\text{nom}} + p < f \leq F_{\text{nom}} + n$	1 kHz
$F_{\text{nom}} + n < f \leq F_{\text{nom}} + m$	10 kHz
$F_{\text{nom}} + m < f \leq 1 \text{ GHz}$	100 kHz
$1 \text{ GHz} < f \leq 6 \text{ GHz}$	1 MHz

NOTE 1: f is the measurement frequency.
 F_{nom} is the nominal operating frequency in MHz.
 m in MHz is $10 \times \text{OCW}$ or 500 kHz, whichever is the greater.
 n in MHz is $4 \times \text{OCW}$ or 100 kHz, whichever is the greater.
 p in MHz is $2,5 \times \text{OCW}$.

NOTE 2: If the value of RBW in kHz used for measurement is different from RBW_{REF}, use bandwidth correction from clause 5.2.9.

The frequency range from $F_{\text{nom}} - 2,5 \times \text{OCW}$ to $F_{\text{nom}} + 2,5 \times \text{OCW}$ which is not part of transmitter spurious domain shall be excluded from the measurements to avoid spectrum analyser's front end overload.

5.3.1.2 Test conditions for Rx and all other modes

- 1) For EUT without an external 50 Ω coaxial antenna connector, the spurious emissions levels shall be established by the radiated measurement procedure in clause 5.3.1.3.1.
- 2) For all other EUT the spurious emissions levels shall be established as both:
 - the radiated measurement procedure in clause 5.3.1.3.1, with the antenna port terminated with a dummy load; and
 - the conducted measurement procedure in clause 5.3.1.3.2.

5.3.1.3 Measurement procedure

5.3.1.3.1 Radiated measurement

For equipment with an external 50 Ω , the antenna port terminated in a 50 Ω non-reactive and non-radiating load (commonly called "dummy load") as illustrated in Figure 7.

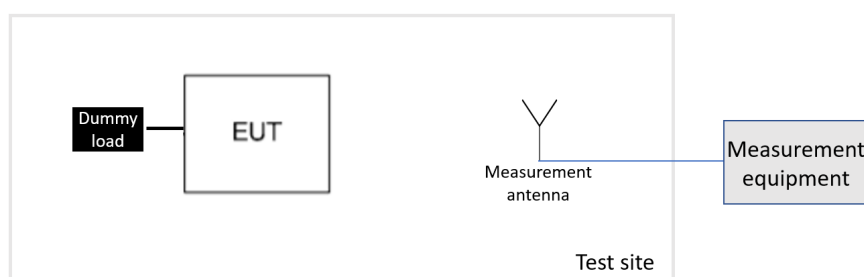

Figure 7: Measurement setup for equipment with an external 50 Ω connector

The measurements shall be performed using the radiated measurement procedure described in clause B.6.2 or clause B.6.3 using the test site selected based on clause B.7, followed by clause B.6.4. The operation of the EUT shall be started with the EUT set to the nominal operating frequency (see clause 5.2.1).

For the spectrum mask in the transmitter spurious domain clause 5.3.1.1 applies.

The measuring receiver shall be tuned over the frequency range shown in Table 27.

Table 27: Tx Spurious domain Radiations radiated Measurement Frequency Range

Frequency Range
30 MHz to 6 GHz

5.3.1.3.1.1 Pre-scan

This pre-scan test procedure shall be used to identify possible unwanted emissions of the EUT in the spurious domain.

Step 1:

- The sensitivity of the spectrum analyser should be such that the noise floor is at least 12 dB below the limits given in Table 4.
- The test equipment shall be configured for the parameters shown in Table 28 for the range 30 MHz to 1 000 MHz.

Table 28: Parameters for radiated pre-scan over the range 30 MHz to 1 000 MHz

Spectrum Analyser Setting	Value
RBW	100 kHz
VBW	3 × RBW
Detector Mode	Peak
Trace Mode	Max hold
Sweep points	≥ 20 000 For spectrum analysers not supporting this number of sweep points, the frequency band may be segmented. For spectrum analysers capable of supporting twice this number of sweep points, the frequency adjustment in clause 5.3.1.3.3 (step 1, last bullet) may be omitted.
Sweep time	For D-M3 test signal, the sweep time shall be such that for each 10 kHz/100 kHz frequency step respectively, the measurement time is greater than two transmissions of the EUT.

- The unwanted emissions over the range 30 MHz to 1 000 MHz shall be identified.
- Allow the trace to stabilize. Any emissions identified that have a margin of less than 6 dB below the limits given in clause 4.3.1.3 shall be individually measured using the procedure in clause 5.3.1.3.3 and compared to the limits given in clause 4.3.1.3.

The maximum signal level detected by the measuring receiver for vertical and horizontal polarization shall be noted.

The radiated measurements in clause B.6.2 or clause B.6.3 using the test site selected based on clause B.7, followed by the substitution measurement defined in clause B.6.4 shall be performed with the frequency of the calibrated signal generator set to the frequency of the spurious component detected and, if necessary, the input attenuator setting of the measuring receiver adjusted to increase the sensitivity of the measuring receiver.

The measure of the effective radiated power of the spurious component is determined by taken the higher of the two power levels at the input to the substitution antenna which is then adjusted by the substitution antenna gain and corrected by the cable loss (values in dB).

Step 2:

- The test equipment shall be configured for the parameters shown in Table 29 for the range 1 GHz to 6 GHz.

Table 29: Parameters for radiated pre-scan over the range 1 GHz to 6 GHz

Spectrum Analyser Setting	Value
RBW	1 MHz
VBW	3 MHz
Detector Mode	Peak
Trace Mode	Max hold
Sweep points	≥ 25 000 For spectrum analysers not supporting this number of sweep points, the frequency band may be segmented. For spectrum analysers capable of supporting twice this number of sweep points, the frequency adjustment in clause 5.3.1.3.3. (step 1, last bullet) may be omitted.
Sweep time	For D-M3 test signal, the sweep time shall be such that for each 1 MHz frequency step, the measurement time is greater than two transmissions of the EUT.

- The unwanted emissions over the range 1 GHz to 6 GHz shall be identified.
- Allow the trace to stabilize. Any emissions identified that have a margin of less than 6 dB below the limits given in clause 4.3.1.3 shall be individually measured using the procedure in clause 5.3.1.3.3 and compared to the limits given in clause 4.3.1.3.

The maximum signal level detected by the measuring receiver for vertical and horizontal polarization shall be noted.

The radiated measurements in clause B.6.2 or clause B.6.3 using the test site selected based on clause B.7, followed by the substitution measurement defined in clause B.6.4 shall be performed with the frequency of the calibrated signal generator set to the frequency of the spurious component detected and, if necessary, the input attenuator setting of the measuring receiver adjusted to increase the sensitivity of the measuring receiver.

The measure of the effective radiated power of the spurious component is the larger of the two power levels at the input to the substitution antenna increased by the substitution antenna gain corrected by the cable loss (values in dB).

5.3.1.3.2 Conducted measurement

The EUT shall be connected to an attenuator (see clause 5.2.4) which shall be connected to the test equipment.

The operation of the EUT shall be started with the EUT set to the nominal operating frequency (see clause 5.2.1).

For the spectrum mask in the transmitter spurious domain clause 5.3.1.1 applies.

The measuring receiver shall be tuned over the frequency range shown in Table 27.

5.3.1.3.2.1 Pre-scan

This pre-scan test procedure shall be used to identify possible unwanted emissions in the Tx spurious domain.

Step 1:

- The sensitivity of the spectrum analyser should be such that the noise floor is at least 12 dB below the limits given in Table 4.
- The test equipment shall be configured for the parameters shown in Table 28 for measurements over the range 30 MHz to 1 000 MHz.
- The unwanted emissions over the range 30 MHz to 1 000 MHz shall be identified.
- Allow the trace to stabilize. Any emissions identified that have a margin of less than 6 dB below the limits given in clause 4.3.1.3 shall be individually measured using the procedure in clause 5.3.1.3.3 and compared to the limits given in clause 4.3.1.3.

Step 2:

- The test equipment shall be configured for the parameters shown in Table 29 for measurements over the range 1 GHz to 6 GHz.

- The unwanted emissions over the range 1 GHz to 6 GHz shall be identified.
- Allow the trace to stabilize. Any emissions identified that have a margin of less than 6 dB with respect to the limits given in clause 4.3.1.3 shall be individually measured using the procedure in clause 5.3.1.3.3 and compared to the limits given in clause 4.3.1.3.

5.3.1.3.3 Measurement of emissions identified during the pre-scan

The steps below shall be used to accurately measure the individual mean power of unwanted emissions identified during the pre-scan measurements above.

For the spectrum mask in the transmitter spurious domain clause 5.3.1.1 applies.

For continuous transmit signals, a simple measurement of mean power using the RMS detector of the spectrum analyser is permitted.

For D-M3 test signals, the measurement shall be made only over the "on" part of the burst.

Step 1:

- The level of the emissions shall be displayed in the zero span mode, using the spectrum analyser settings shown in Table 30.

Table 30: Parameters for emissions identified by pre-scan

Spectrum Analyser Setting	Value
Centre Frequency	Frequency of emission identified during pre-scan
RBW	30 MHz $\leq f < 1$ GHz 1 MHz for 1GHz $\leq f \leq 6$ GHz
VBW	3 x RBW
Frequency span	Zero span
Sweep mode	Single sweep
Sweep time	Suitable to capture one transmission burst. Additional measurements may be needed to identify the length of the transmission burst. In case of continuous signals, the Sweep Time shall be set to 30 ms
Sweep points	Sweep time [μ s] / 1 μ s with a maximum of 30 000
Trigger mode	Video (burst signal) or Manual (continuous signal)
Detector Mode	RMS
Trace Mode	Clear/Write

- Adjust the centre frequency (fine tune) to capture the highest level of one burst of the emission to be measured. This fine tuning can be omitted for spectrum analysers capable of supporting twice this number of sweep points required in step 2 and step 3 from the pre-scan procedure in clause 5.3.1.3.1.1 for radiated measurement and clause 5.3.1.3.2.1 for conducted measurement.

Step 2:

- Adjust the trigger level to select the transmissions with the highest power level.
- Set a window (start and stop lines) to match with the start and end of the burst and in which the RMS power shall be measured using the Power function. If the unwanted emission to be measured is a continuous signal, the measurement window shall be set to match the start and stop times of the sweep.
- Select RMS power to be measured within the selected window and note the result which is the RMS power of this spurious emission. Compare this value with the applicable limit provided by clause 4.3.1.3.

Repeat this procedure for every emission identified during the pre-scan. The values and corresponding frequencies shall be recorded as shown in Table 31.

Table 31: Information recorded in the test report for Spectrum mask in the transmitter spurious domain

Parameter	Value Recorded in the Test Report
Emission Frequency	The frequency of the emission
Emission Power	The rms power value displayed by the spectrum analyser

5.4 Conformance methods of measurement for transmitters

5.4.1 Effective radiated power

5.4.1.1 General

- 1) The measurement shall be performed on the EUT set to the nominal operating frequency (see clause 5.2.1) at the highest power level at which the EUT is intended to operate.
- 2) The EUT shall be switched on without modulation, if D-M1 is available. For an EUT with non-constant-envelope modulation, test signal D-M1 shall not be used.
- 3) An EUT without a permanent or temporary antenna connector shall be tested according to clause 5.4.1.2.
- 4) An EUT with a permanent or temporary antenna connector shall be tested according to clause 5.4.1.3.

5.4.1.2 Radiated measurement procedure

5.4.1.2.1 Test conditions

- 1) In the case of a removable antenna, the antenna shall be fitted in a manner representative of the intended use.
- 2) The test equipment shall be configured for the parameters shown in Table 32.

Table 32: Test parameters for Effective radiated power measurement

Setting	Value	Notes
Detector mode	RMS	
Span	Width of the PFB	According to Table E.1 and Table F.1
RBW	larger than the OCW	
VBW	3 × RBW	Nearest setting to 3 × RBW
NOTE:	RBW can be verified to be large enough by measuring the signal at successively smaller RBW settings until the measured power is lower than the preceding measurement. At this point the measuring receiver is no longer capturing the full signal. RBW should be set to be no smaller than the preceding value for which no change was indicated with its preceding larger value.	

5.4.1.2.2 Measurement procedure

A test site is selected from those described in clause B.2 according to clause B.7 and the radiated power is established using the corresponding radiated measurement procedure described in clause B.6 The higher absolute power value for vertical or horizontal polarization shall be measured.

The information shown in Table 33 shall be recorded in the test report.

Table 33: Information to be recorded in the test report for effective radiated power

Value	Notes
Test signal	The test signal used (see clause 5.2.7, Table 24)
EUT frequency	EUT nominal operating frequency tested (see Annex I)
Measure of Effective Radiated Power	The higher value from horizontal and vertical polarization measurement effective radiated power

5.4.1.3 Conducted measurement procedure

5.4.1.3.1 Test conditions

The EUT shall be connected to an attenuator (see clause 5.2.4) which shall be connected to the measuring receiver.

The test equipment shall be configured for the parameters shown in Table 32.

5.4.1.3.2 Measurement procedure

The higher absolute power value measured for vertical or horizontal polarization delivered to the measuring receiver shall be measured.

The information shown in Table 34 shall be recorded in the test report.

Table 34: Information recorded in the test report for conducted Effective Radiated Power

Value	Notes
Test signal	The test signal used (see clause 5.2.7, Table 24)
EUT frequency	EUT nominal operating frequency tested (see Annex I)
Measured power (Conducted)	Maximum measured conducted power value
NOTE:	The maximum permitted gain relative to a half wave dipole for any antenna used with the EUT is the e.r.p. limit specified Table 5 minus the measured conducted power.

5.4.2 Maximum occupied bandwidth

5.4.2.1 Test conditions

- 1) The measurement shall be performed on the EUT set to the nominal operating frequency (see clause 5.2.1).
- 2) The measurement shall be performed with a spectrum analyser.
- 3) An EUT without a permanent or temporary antenna connector shall be tested according to clause 5.4.2.2.
- 4) An EUT with a permanent or temporary antenna connector shall be tested according to clause 5.4.2.3.

5.4.2.2 Radiated measurement

A test site is selected from those described in clause B.2 according to clause B.7 and the measurements in clause 5.4.2.4 shall be performed using the corresponding radiated measurement procedure described in clause B.6.

5.4.2.3 Conducted measurement

The EUT shall be connected to an attenuator (see clause 5.2.4) which shall be connected to a spectrum analyser. The measurements in clause 5.4.2.4 shall be performed.

5.4.2.4 Measurement procedure

The spectrum analyser shall be configured for the parameters shown in Table 35.

Table 35: Test parameters for Occupied Bandwidth measurement

Setting	Value	Notes
Centre frequency	EUT nominal operating frequency	
RBW	1 % to 3 % of OCW without being below 100 Hz	
VBW	3 × RBW	Smallest available analyser setting greater than or equal to 3 × RBW
Span	2 times the Operating Channel Width (OCW)	Span should be large enough to include all major components of the signal and its side bands
Detector Mode	RMS	
Trace	Max. hold	

Step 1:

Operation of the EUT shall be started on the EUT nominal operating frequency with test signal in accordance with clause 5.2.7 (see Table 24).

The signal attenuation shall be adjusted to ensure that the -23 dBc points are at least 10 dB above the noise floor of the analyser to avoid the noise signals on either side of the power envelope being included in the measurement.

Step 2:

When the trace is completed the peak value of the trace shall be located and the analyser marker placed on this peak.

Step 3:

The 99 % occupied bandwidth function of the spectrum analyser shall be used to measure the occupied bandwidth of the signal. Occupied bandwidth frequency edges $FOBW_{low}$ and $FOBW_{high}$ shall be measured.

If the spectrum analyser does not have a 99 % OBW function, recover the trace data points and sum directly in linear power terms. Place the recovered amplitude data points starting from the lowest frequency, in a running sum until 0,5 % of the total is reached. Record that frequency as the lower OBW frequency. Repeat the process until 99,5 % of the total is reached and record that frequency as the upper OBW frequency. The 99 % power OBW is then determined by computing the difference between these two frequencies. The OBW shall be reported and plot(s) of the spectrum analyser display shall be provided with the test report. The frequency and amplitude axis and scale shall be labelled. Tabular data can be reported in addition to the plot(s).

The information shown in Table 36 shall be recorded in the test report over the full environmental profile.

Table 36: Information to be recorded in the test report for Occupied Bandwidth

Value	Notes
EUT frequency	Nominal operating frequency tested (see Annex I)
Instantaneous Occupied Bandwidth Value (OBW)	The value measured with the spectrum analyser
Lower frequency edge ($FOBW_{low}$)	The value measured with the spectrum analyser
Upper frequency edge ($FOBW_{high}$)	The value measured with the spectrum analyser
Highest measured occupied bandwidth value (OBW_{high})	Highest measured OBW value over the full environmental profile

5.4.3 Frequency error

5.4.3.1 Test conditions

- 1) The measurement shall be performed on the EUT set to the nominal operating frequency (see clause 5.2.1).
- 2) The measurement shall be performed with a spectrum analyser.
- 3) An EUT without a permanent or temporary antenna connector shall be tested according to clause 5.4.1.2.
- 4) An EUT with a permanent or temporary antenna connector shall be tested according to clause 5.4.1.3.

5.4.3.2 Radiated measurement

A test site is selected from those described in clause B.2 according to clause B.7 and the measurements shall be performed using the corresponding radiated measurement procedure described in clause B.6. The measurement procedure in clause 5.4.3.4 shall apply if D-M1 signal is available otherwise for all other test signals from clause 5.2.7, Table 23, the measurement procedure given in clause 5.4.3.5 shall be performed.

5.4.3.3 Conducted measurement

The EUT shall be connected to the spectrum analyser via an attenuator (see clause 5.2.4). The measurement procedure in clause 5.4.3.4 shall apply if D-M1 signal (see clause 5.2.7, Table 24) is available otherwise for all other test signals from clause 5.2.7 Table 24 the measurement given in clause 5.4.3.5 shall be performed.

5.4.3.4 Measurement procedure for D-M1 test signal

The spectrum analyser shall be configured for the parameters shown in Table 37.

Table 37: Test parameters for Frequency Error measurement

Setting	Value	Notes
Centre frequency	EUT nominal operating frequency	
RBW	Below 1 % of OCW	
VBW	3 × RBW	Smallest available analyser setting greater than or equal to 3 × RBW
Span	OCW	
Detector Mode	RMS	
Trace	Max. hold	

The measurement shall be performed with an unmodulated carrier test signal (D-M1).

Step 1:

Operation of the EUT shall be started on the nominal operating frequency at 25 °C temperature condition. The measurements shall be performed over the full range of temperature and voltage conditions from the environmental profile to measure the drift of the frequency and to determine the highest frequency of the unmodulated carrier (A). The frequency shall be measured and noted.

Step 2:

Operation of the EUT shall be started on the nominal operating frequency at 25 °C temperature condition. The measurements shall be performed over the full range of temperature and voltage conditions from the environmental profile to measure the drift of the frequency and to determine the lowest frequency of the unmodulated carrier (B). The frequency shall be measured and noted.

The information shown in Table 38 shall be recorded in the test report.

Table 38: Information recorded in the test report for Frequency Error measurement using unmodulated carrier

Value	Notes
Test signal	The test signal used (see clause 5.2.7, Table 24)
EUT nominal operating frequency (F)	Nominal operating frequency tested (see Annex I)
Measured centre frequency (A)	Measured unmodulated highest centre frequency
Measured centre frequency (B)	Measured unmodulated lowest centre frequency
Frequency error over environmental profile	Maximum of absolute value of (A-F) and (B-F)

5.4.3.5 Measurement procedure for other test signal

The spectrum analyser shall be configured for the parameters shown in Table 37.

The measurement shall be performed with modulated carrier test signal according to clause 5.2.7, Table 24.

Step 1:

Operation of the EUT shall be started on the nominal operating frequency.

Step 2:

The 99 % occupied bandwidth function of the spectrum analyser shall be used to measure the occupied bandwidth of the signal. Pairs of occupied bandwidth frequency edges $FOBW_{low}$ and $FOBW_{high}$ shall be measured over the full range of temperature and voltage conditions from the environmental profile.

If the spectrum analyser does not have a 99 % OBW function, recover the trace data points and sum directly in linear power terms. Place the recovered amplitude data points starting from the lowest frequency, in a running sum until 0,5 % of the total is reached. Record that frequency as the lower OBW edge frequency ($FOBW_{low}$). Repeat the process until 99,5 % of the total is reached and record that frequency as the upper OBW edge frequency ($FOBW_{high}$).

For each measurement compute the centre frequency of the occupied bandwidth as $CF = (FOBW_{low} + FOBW_{high})/2$.

CF_{low} is the lowest centre frequency of measured OBW over the environmental profile.

CF_{high} is the highest centre frequency of measured OBW over the environmental profile.

The information shown in Table 39 shall be recorded in the test report.

Table 39: Information Recorded in the test report for Frequency Error measurement using modulated signal

Value	Notes
Test signal	The test signal used. See clause 5.2.7, Table 24
EUT frequency (f)	Nominal operating frequency tested (see Annex I)
CF_{low}	Lowest centre frequency of measured OBW over full environmental profile
CF_{high}	Highest centre frequency of measured OBW over full environmental profile
Frequency error over environmental profile	Maximum of absolute value of ($CF_{low} - f$) and ($CF_{high} - f$)

5.4.4 Transmitter Signal at the edges of the TxOFB

5.4.4.1 Test condition

- 1) The measurement shall be performed on the EUT set to the nominal operating frequency (as per clause 5.2.1).
- 2) The measurement shall be performed with a spectrum analyser.
- 3) An EUT without a permanent or temporary antenna connector shall be tested according to clause 5.4.4.2.
- 4) An EUT with a permanent or temporary antenna connector shall be tested according to clause 5.4.4.3.

5.4.4.2 Radiated measurement

A test site is selected from those described in clause B.2 according to clause B.7 and the measurements shall be performed using corresponding radiated measurement procedure described in clause B.6. The measurements in clause 5.4.4.4 shall be performed.

5.4.4.3 Conducted measurement

The EUT shall be connected to the spectrum analyser via an attenuator (see clause 5.2.4). The measurement in clause 5.4.4.4 shall be performed.

5.4.4.4 Measurement procedure

The spectrum analyser shall be configured for the parameters shown in Table 35.

The measurement shall be performed with modulated carrier test signal according to clause 5.2.7, Table 24.

Step 1:

Operation of the EUT shall be started on the nominal operating frequency.

Step 2:

OBW frequency edges $FOBW_{low}$ and $FOBW_{high}$ are measured considering clause 5.4.2 at the extremes of the temperature and voltage ranges from the environmental profile.

Min $FOBW_{low}$ is the smallest lower frequency edge of OBW measured over environmental profile.

Max $FOBW_{high}$ is the highest upper frequency edge of OBW measured over environmental profile.

The information shown in Table 40 shall be recorded in the test report.

Table 40: Information recorded in the test report for Tx signal at the edges of the TxOFB

Value	Notes
Test signal	The test signal used (see clause 5.2.7, Table 24)
EUT frequency	Nominal operating frequency tested
FOC_{low}	Lower operating channel edge
FOC_{high}	Upper operating channel edge
Min $FOBW_{low}$	Smallest measured lower frequency edge of OBW over full environmental profile
Max $FOBW_{high}$	Highest measured upper frequency edge of OBW over full environmental profile

5.4.5 Transient power

5.4.5.1 General

- 1) The measurements shall be performed using a spectrum analyser or equivalent measuring equipment.
- 2) The measurement shall be performed on the EUT set to the nominal operating frequency (as per clause 5.2.1).
- 3) The measurements shall be performed at the highest power level at which the transmitter is intended to operate.
- 4) An EUT without a permanent connector or a temporary antenna connector shall be tested according to clause 5.4.5.2.
- 5) An EUT with a permanent connector or with a temporary antenna connector shall be tested according to clause 5.4.5.3.

5.4.5.2 Radiated measurement

A test site is selected from those described in clause B.2 according to clause B.7 and the measurements in clause 5.4.5.4 shall be performed using the corresponding radiated measurement procedure described in clause B.6.

5.4.5.3 Conducted measurement

The EUT shall be connected to an attenuator (as per clause 5.2.4) which shall be connected to the test equipment.

The measurements in clause 5.4.5.4 shall be performed.

5.4.5.4 Measurement procedure

The measurement shall be undertaken in zero span mode. The analyser's centre frequency shall be set to an offset from the nominal operating frequency. These offset values and their corresponding RBW configurations are listed in Table 41.

Table 41: Measurement Offsets & RBW for transient Power measurement

Measurement points: offset from centre frequency	Analyser RBW	RBW _{REF}
-0,5 x OCW - 3 kHz 0,5 x OCW + 3 kHz Not applicable for OCW < 25 kHz	1 kHz	1 kHz
±12,5 kHz or ±OCW whichever is the greater	Max (RBW pattern 1, 3, 10 kHz) ≤ Offset frequency/6 (see note)	1 kHz
-0,5 x OCW - 400 kHz 0,5 x OCW + 400 kHz	100 kHz	1 kHz
-0,5 x OCW - 1 200 kHz 0,5 x OCW + 1 200 kHz	300 kHz	1 kHz
NOTE: Max (RBW pattern 1, 3, 10 kHz) means the maximum bandwidth that falls into the commonly implemented 1,3,10 kHz RBW filter bandwidth pattern of the spectrum analysers. EXAMPLE: If OCW is 25 kHz then the RBW value corresponding to one OCW offset frequency is 3 kHz. The rest of the analyser settings are listed in Table 42, and if OCW is 250 kHz then the RBW value corresponding to one OCW offset frequency is 30 kHz.		

The used modulation shall be D-M3. The analyser shall be set to the settings of Table 42 and a measurement shall be performed for each offset frequency given in Table 41. The EUT shall transmit at least five D-M3 test signals.

Table 42: Parameters for transient measurement

Spectrum Analyser Setting	Value	Notes
VBW/RBW	10	At higher RBW values VBW may be clipped to its maximum value.
Sweep time	500 ms	
RBW filter	Gaussian	
Trace Detector Function	RMS	
Trace Mode	Max hold	
Sweep points	501	
Measurement mode	Continuous sweep	
NOTE: The ratio between the number of sweep points and the sweep time shall be the same ratio as above if different number of sweep points is used.		

The recorded power values shall be converted to power values measured in RBW_{REF} by the formula in clause 5.2.8.2.

The information shown in Table 43 shall be recorded in the test report.

Table 43: Information to be recorded in the test report for Transient power

Value	Notes
EUT frequency	Nominal operating frequency tested (see Annex I)
Offset frequency	See Table 41
Peak measured power	The peak power value displayed by the spectrum analyser
Peak power	Calculated peak power in RBW_{REF} (see clause 5.2.9.2)

5.4.6 Spectrum mask in the transmitter out-of-band domain

5.4.6.1 Test conditions

- 1) An EUT without a permanent or temporary antenna connector shall be tested according to clause 5.4.6.2.
- 2) An EUT with a permanent or temporary antenna connector shall be tested according to clause 5.4.6.3.

5.4.6.2 Radiated measurement

A test site is selected from those described in clause B.2 according to clause B.7 and the measurements in clause 5.4.6.4 shall be performed using the corresponding radiated measurement procedure described in clause B.6.

5.4.6.3 Conducted measurement

The EUT shall be connected to an attenuator (as per clause 5.2.4) which shall be connected to the test equipment.

The measurements in clause 5.4.6.4 shall be performed.

5.4.6.4 Measurement procedure

The test equipment shall be configured with parameters shown in Table 44.

Table 44: Test Parameters for the spectrum mask in the Tx out of band emissions

Spectrum Analyser Setting	Value	Notes
EUT frequency	f_{nom}	Nominal operating frequency tested.
Span	$6 \times OCW$	
RBW	1 kHz (see note)	Resolution bandwidth for Spectrum mask in the Tx out-of-band domain measurements.
Detector Function	RMS	
Trace Mode	Linear averaging	Applies only for EUT generating D-M2 test signal.
	Max Hold	Applies only for EUT generating D-M3 test signal.
NOTE: If the value of RBW used is different from RBW_{REF} in clause 4.4.6 Table 10, use the bandwidth correction described in clause 5.2.8.2.		

Step 1:

The EUT shall be started on the nominal operating frequency (as per clause 5.2.1) and set to max output power level with test signal selected from clause 5.2.7 (see Table 24).

Step 2:

The signal shape is recorded in the test report when stable.

5.4.7 Adjacent channel power

5.4.7.1 Test conditions

- 1) The measurement shall be performed on the EUT set to the nominal operating frequency (as per clause 5.2.1).
- 2) The measurement shall be performed with the EUT operating at its maximum operating power level.
- 3) An EUT without a permanent or temporary antenna connector shall be tested according to clause 5.4.7.2.
- 4) An EUT with a permanent or temporary antenna connector shall be tested according to clause 5.4.7.3.

5.4.7.2 Radiated measurement

A test site shall be selected from those described in clause B.2 according to clause B.7 and the measurements in clause 5.4.7.4 shall be performed using the corresponding radiated measurement procedure described in clause B.6.

5.4.7.3 Conducted measurement

The EUT shall be connected to an attenuator (as per clause 5.2.4) which shall be connected to the test equipment.

The measurements in clause 5.4.7.4 shall be performed.

5.4.7.4 Measurement procedure

The spectrum analyser shall be configured with parameters shown in Table 45.

Table 45: Test parameters for Adjacent Channel Power

Setting	Value	Notes
EUT frequency	F_{nom}	Nominal operating frequency tested (see Annex I)
RBW	100 Hz	
VBW	$\geq 3 \times RBW$	
Span	At least $5 \times$ Operating Channel width	Span should be large enough to include Adjacent and Alternate Adjacent Channel
Detector Mode	RMS	
Trace mode	Max hold	Applies only for EUT generating D-M3 test signal

Step 1:

Operation of the EUT shall be started on the nominal operating frequency (as per clause 5.2.1) with test signal selected from clause 5.2.7 (see Table 24).

The signal attenuation shall be adjusted to ensure that the signal power is not saturating the spectrum analyser input port.

Step 2:

When the trace is completed, read the integrated power over a bandwidth of RBW_{REF} centered on an offset from centre frequency as specified in Table 46. The spectrum analyser's ACP personality or an integrating marker may be used. If the spectrum analyser's ACP personality is used any additional filtering over the integrating bandwidth shall be disabled.

Table 46: Offset and RBW_{REF} parameters

Measurement	Offset from centre frequency	RBW_{REF}
Adjacent channel	$\pm OCW$	$0,7 \times OCW$
Second adjacent channel	$\pm 2 \times OCW$	$0,7 \times OCW$

The information shown in Table 47 shall be recorded.

Table 47: Information to be recorded in the test report for Adjacent channel power

Value	Notes
EUT frequency	Nominal operating frequency tested
Lower adjacent channel power	The value measured with the spectrum analyser at $F_{nom} - OCW$
Upper adjacent channel power	The value measured with the spectrum analyser at $F_{nom} + OCW$
Lower second adjacent channel power	The value measured with the spectrum analyser at $F_{nom} - 2 \times OCW$
Upper second adjacent channel power	The value measured with the spectrum analyser at $F_{nom} + 2 \times OCW$

5.4.8 Transmitter spectrum mask at permitted frequency band edges

5.4.8.1 Test conditions

- 1) An EUT without a permanent or temporary antenna connector shall be tested according to clause 5.4.8.2.
- 2) An EUT with a permanent or temporary antenna connector shall be tested according to clause 5.4.8.3.

5.4.8.2 Radiated measurement

A test site is selected from those described in clause B.2 according to clause B.7 and the measurements shall be performed according to clause 5.4.8.4 using the corresponding radiated measurement procedure described in clause B.6.

5.4.8.3 Conducted measurement

The EUT shall be connected to an attenuator (as per clause 5.2.4) which shall be connected to the test equipment. The measurements in clause 5.4.8.4 shall be performed.

5.4.8.4 Measurement procedure

The test equipment shall be configured with parameters shown in Table 48.

Table 48: Test parameters for transmitter spectrum mask at permitted frequency band edges

Spectrum Analyser Setting	Value	Notes
EUT frequency	F_{nom}	Nominal operating frequency tested (see Annex I)
Span	$PFB_{low} - 450 \text{ kHz}$ to $PFB_{high} + 450 \text{ kHz}$	
RBW	1 kHz (see note)	
Detector Function	RMS	
Trace Mode	Linear AVG	Applies only for EUT generating D-M2 test signal
	Max Hold	Applies only for EUT generating D-M3 test signal.
NOTE: If the value of RBW used is different from RBW_{REF} in clause 4.4.8 Table 12, use the bandwidth correction described in clause 5.2.8.2.		

Step 1:

Operation of the EUT shall be started on the nominal operating frequency (as per clause 5.2.1) with test signal selected from clause 5.2.7, Table 24.

The signal shape is recorded when stable.

5.4.9 Duty cycle

5.4.9.1 Test conditions

Assessment of the overall duty cycle shall be made for a representative period of T_{obs} over the observation bandwidth F_{obs} . Unless otherwise specified, T_{obs} is 1 hour and the observation bandwidth F_{obs} is the permitted frequency band (see Table E.1 and Table F.1).

The EUT shall be configured to transmit in a manner representative of normal operation for its intended use. As a guide "normal use" is considered as representing the behaviour of the device during transmission of 99 % of transmissions generated during its operational lifetime.

Procedures such as setup, commissioning and maintenance are not considered part of normal operation.

Where an acknowledgement is used, the additional transmitter on-time from a message responder shall be taken into account only once whether included in the message initiator duty cycle or in the message responder duty cycle.

NOTE: The intention of this rule is not to allow EUT to exceed the maximum duty cycle value.

- 1) An EUT without a permanent or temporary antenna connector shall be tested according to clause 5.4.9.2.
- 2) An EUT with a permanent or temporary antenna connector shall be tested according to clause 5.4.9.3.

5.4.9.2 Radiated measurement

A test site is selected from those described in clause B.2 according to clause B.7 and the measurements shall be performed according to clause 5.4.9.4 using the corresponding radiated measurement procedure described in clause B.6.

5.4.9.3 Conducted measurement

The EUT shall be connected to an attenuator (as per clause 5.2.4) which shall be connected to the test equipment. The measurements in clause 5.4.9.4 shall be performed.

5.4.9.4 Measurement procedure

The power sensing equipment shall be configured for the parameters specified in Table 49.

Table 49: Power sensing settings for the duty cycle measurement

Setting	Value	Notes
Sample rate	≥ 1 M samples/second	Sampling rate for at least 1 μs resolution
Trigger		Trigger setting to capture leading edge of first transmission
Frequency		Centre frequency of the power measurement bandwidth
Bandwidth	Permitted frequency band as defined in Tables E.1 and F.1	Bandwidth within which power measurements are made
$P_{\text{threshold}}$	-26 dBc	Signal threshold

The EUT signal shall be measured with a power sensor and its levels adjusted according to the power envelope of the EUT transmissions.

NOTE: It is recommended to use a Real Time Spectrum Analyser for those measurements.

If power sensing device's memory cannot store 1 hour of measurement, it is allowed to perform successive measurements of several periods until reaching 1 hour.

Step 1:

The EUT shall be set to operate with a test signal representative of normal operation of the EUT for its intended use. The power sensing equipment shall be used to sample power in the observation bandwidth for the observation period.

The sampled power readings shall be saved.

Step 2:

The start time and stop time of each sequence of samples above $P_{\text{threshold}}$ during T_{obs} shall be obtained. The T_{On} times shall be determined using the procedures defined in Annex D. Between the saved start and stop times of each individual burst, the T_{On} shall be calculated. These T_{On} values shall be saved.

Duty cycle is the sum of the transmitter on periods divided by the observation period T_{obs} .

The information shown in Table 50 shall be recorded in the test report.

Table 50: Information to be recorded in the test report for the duty cycle requirement

Parameter	Value Recorded in the Test Report
Test signal	The test signal used (see clause 5.2.7, Table 24)
Duty cycle	The calculated value of $\sum T_{\text{On}}$ / observation period

5.4.10 Adaptive power control

5.4.10.1 Test conditions

- 1) The measurement shall be performed on the EUT set to the nominal operating frequency (as per clause 5.2.1).
- 2) The measurement shall be performed with the EUT operating at its highest supported maximum transmit power.
- 3) The EUT and companion device shall be configured to operate in normal operating mode.
- 4) The measurements shall be performed over the APC settling time interval (see Annex I).
- 5) An EUT without a permanent or temporary antenna connector shall be tested according to clause 5.4.10.2.
- 6) An EUT with a permanent or temporary antenna connector shall be tested according to clause 5.4.10.3.

5.4.10.2 Radiated measurement

A test site is selected from those described in clause B.2 according to clause B.7 and the measurements shall be performed according to clause 5.4.10.4 using the corresponding radiated measurement procedure described in clause B.6.

5.4.10.3 Conducted measurement

The EUT shall be connected to an attenuator (as per clause 5.2.4) which shall be connected to the test equipment.

The measurements in clause 5.4.10.4 shall be performed.

5.4.10.4 Measurement procedure

The test equipment shall be configured for the parameters shown in Table 51.

Table 51: Test parameters settings for automatic / adaptive power control measurement

Parameter	Value
RBW	Permitted frequency band as defined in Table E.1 and Table F.1
Detector mode	Peak

Step 1:

EUT shall be connected to a companion equipment as shown in Figure 8.

Step 2:

The variable attenuator shall be adjusted such that the attenuation between points A and B is 75 dB.

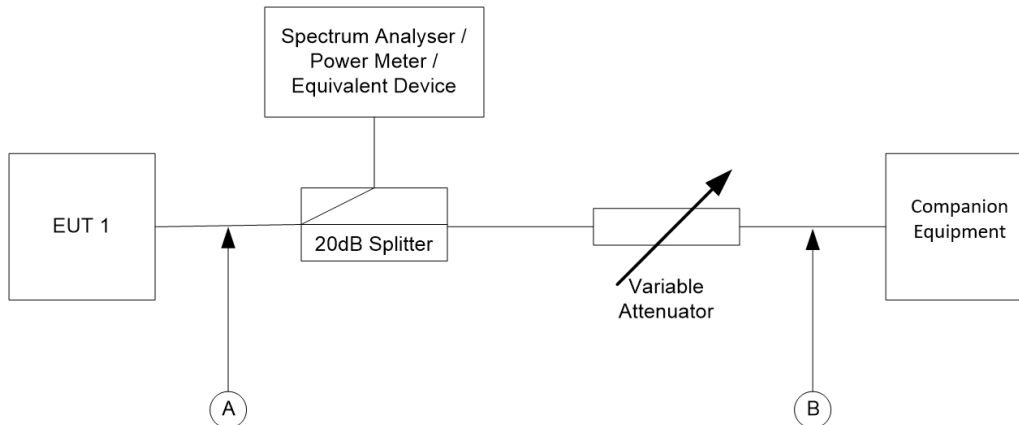

Figure 8: APC measurement setup

The EUT and the companion equipment shall be set to communicate with each other, for at least the APC settling time (see Annex I), with a permitted test signal (see clause 5.2.7, Table 24).

The test equipment shall then be used to measure power for at least 60 seconds time.

NOTE: The power measuring interval should be sufficiently long to capture transmissions from the EUT.

The information shown in Table 52 shall be recorded in the test report.

Table 52: Information to be recorded in the test report for automatic / adaptive power control

Value	Notes
Test signal	The test signal used (see clause 5.2.7, Table 24)
EUT frequency	F_{nom}
Settling time	APC settling time
Transmitter power level	Peak measured power

5.4.11 Transmitter behaviour under low voltage conditions

5.4.11.1 Test conditions

- 1) An EUT without a permanent or temporary antenna connector shall be tested according to clause 5.4.11.2.
- 2) An EUT with a permanent or temporary antenna connector shall be tested according to clause 5.4.11.3.

5.4.11.2 Radiated measurement

The measurements shall be performed using the procedure in clause 5.4.11.4 using a test site selected according to clause B.7 and using corresponding radiated measurement procedure described in clause B.6.2 or clause B.6.3 depending on the test site, followed by clause B.6.4.

5.4.11.3 Conducted measurement

The EUT shall be connected to an attenuator (as per clause 5.2.4) which shall be connected to the test equipment.

The transmitter output of the EUT shall be connected to power sensing equipment via an attenuator (see clause 5.2.4).

The measurements in clause 5.4.11.4 shall be performed.

5.4.11.4 Measurement procedure

Step 1:

Operation of the EUT shall be started on the nominal operating frequency (as per clause 5.2.1) with test signal as given in Table 24 and with the EUT operating at nominal operating voltage.

The transmitted signal trace shall be measured and noted.

Step 2:

The operating voltage shall be reduced by 10 % steps of nominal voltage until the voltage reaches zero.

The signal frequency and power level of the transmitted signal at peak power shall be measured and noted.

Any transmitted signal in PFB exceeding allowed duty cycle value shall be recorded in the test report.

Any signal measured outside PFB and exceeding spurious level shall be recorded in the test report.

5.5 Conformance methods of measurement for receivers

5.5.1 Receiver sensitivity

5.5.1.1 Test conditions

- 1) The measurements shall be performed for each data rate at which the EUT is able to operate.
- 2) An EUT without a permanent or temporary antenna connector shall be tested according to clause 5.5.1.2.
- 3) An EUT with a permanent or temporary antenna connector shall be tested according to clause 5.5.1.3.

5.5.1.2 Radiated measurement

A test site selected from those described in clause B.2 according to clause B.7.

The output of the signal generator shall be connected to a transmit test antenna. The transmit test antenna shall be placed in the test site.

The EUT shall be placed at the location of the turntable at the orientation of the most sensitive position.

For a transceiver EUT, the most sensitive position is the same position as where the maximum e.r.p. was measured. For receiver only EUT, the measurement test clause 5.5.1.4 shall be performed at different angles from the turntable until a maximum is reached.

The measurement in clause 5.5.1.4 shall be performed using a radiated measurement method described in clause B.6.5.

5.5.1.3 Conducted measurement

The EUT shall be connected to the output of a signal generator.

The measurements in clause 5.5.1.4 shall be performed.

5.5.1.4 Measurement procedure

Step 1:

The signal generator, modulated with a permitted test signal (see clause 5.2.7 Table 24), shall be set to the nominal operating frequency (see clause 5.2.1).

Step 2:

The operation of the EUT shall be started as a receiver on the nominal operating frequency.

Step 3:

The level of the signal generator shall be adjusted to the minimum level at which the wanted criteria (as per clause 4.2.1) is just exceeded.

Step 4:

With the signal generator settings unchanged, the power received by the EUT shall be established.

The receiver sensitivity shall be noted.

Step 5:

Steps 1 to 4 shall be repeated for each data rate at which the EUT is able to operate.

The information shown in Table 53 shall be recorded in the test report.

Table 53: Information to be recorded in the test report for sensitivity

Value	Notes
Test signal	The test signal used (see clause 5.2.7, Table 24)
Data rate	EUT data rate
Measurement method	BER/message success ratio
Measurement description	Description of BER
EUT frequency	Nominal operating frequency tested (see Annex I)
Receiver sensitivity	Power level at RX input

5.5.2 Adjacent channel selectivity

5.5.2.1 Test conditions

- 1) The measurement shall be performed on the EUT set to the nominal operating frequency (as per clause 5.2.1).
- 2) An EUT without a permanent or temporary antenna connector shall be tested according to clause 5.5.2.2.
- 3) An EUT with a permanent or temporary antenna connector shall be tested according to clause 5.5.2.3.

5.5.2.2 Radiated measurement

A test site is selected from those described in clause B.2 according to clause B.7

Signal generators A and B together with the combiner, shown in Figure 9, shall be placed outside the test site for full anechoic and semi anechoic rooms. For OATS, signal generators A and B with the combiner shall be on a table behind the transmit test antenna.

The output of the combiner shall be connected to a transmit test antenna. The transmit test antenna shall be placed in the test site.

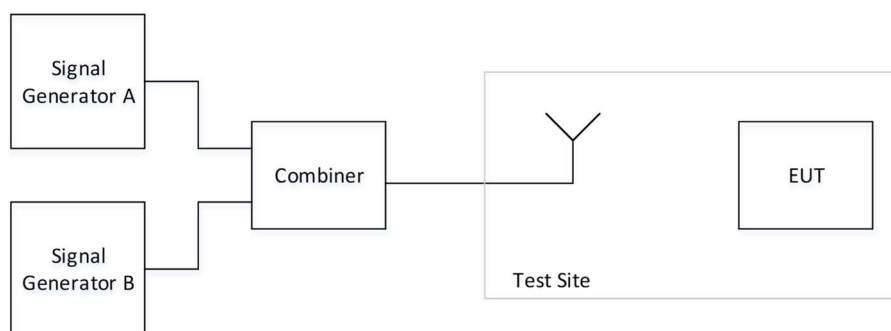

Figure 9: Radiated test measurement arrangement

The EUT shall be placed on the turntable at the orientation of the most sensitive position.

The measurements in clause 5.5.2.4 shall be performed using a radiated measurement method described in clause B.6.5.

5.5.2.3 Conducted measurement

Two signal generators A and B shall be connected to the EUT via a combining network as shown in Figure 10.

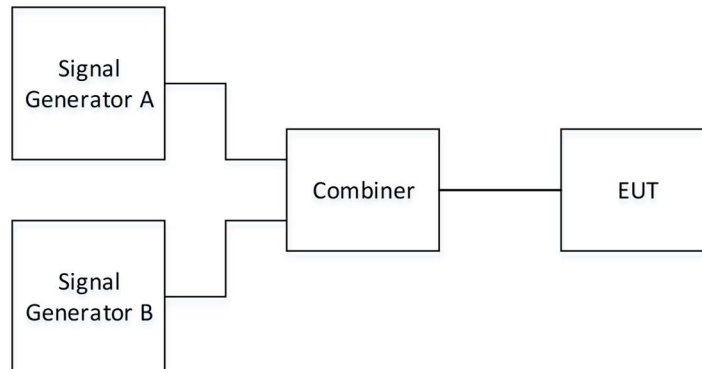

Figure 10: Conducted test measurement arrangement

The measurements in clause 5.5.2.4 shall be performed.

5.5.2.4 Measurement procedure

Signal generator A shall be configured to generate the wanted signal at the EUT nominal operating frequency (as per clause 5.2.1).

Step 1:

Signal generator B shall be unmodulated and shall be adjusted to the nominal operating frequency + OCW i.e. the adjacent channel centre frequency immediately above the operating channel.

Signal generator B RF signal shall be muted.

Step 2:

Signal generator A shall be set to the minimum level which gives the wanted performance criterion of the EUT (as measured in clause 4.2.1) or the reference level in Table 16, whichever is the higher. The output level of signal generator A shall then be increased by 3 dB.

Step 3:

Signal generator B is then unmuted and the signal amplitude shall be adjusted to the minimum level at which the wanted performance criteria (see clause 4.2.1) is just not achieved or the limit specified in Table 15 for S+3 dB is reached.

The ACS is then the power received from generator B at the EUT antenna connector.

This can either be measured on the antenna connector in case of conducted tests or be calculated for radiated test (e.g. $ACS = Tx \text{ power generator B} - \text{combiner loss} + \text{antenna gain test antenna} + \text{antenna gain EUT} - \text{path loss}$) (see clause B.6.5).

Step 4:

The measurement in steps 1 to 3 shall be repeated with signal generator B adjusted to the nominal operating frequency - OCW in step 1 i.e. the adjacent channel centre frequency immediately below the Operating Channel.

Step 5:

The measurements in steps 1 to 3 shall be repeated with:

- 1) In step 1: Signal generator B adjusted to the nominal operating frequency + OCW i.e. the adjacent channel centre frequency immediately above the Operating Channel.
- 2) In step 2: the signal generator A shall be set to the minimum level which gives the wanted performance criterion of the EUT (as measured in clause 4.2.1) or the reference level in Table 15, whichever is the higher. The output level of signal generator A shall then be increased by 23 dB.
- 3) In step 3: Signal generator B is then unmuted and the signal amplitude shall be adjusted to the minimum level at which the wanted performance criteria (see clause 4.2.1) is just not achieved or the limit specified in Table 16 for S+23 dB.

Step 6:

The measurements in step 5 shall be repeated with:

- 1) In step 1: Signal generator B adjusted to the nominal operating frequency - OCW i.e. the adjacent channel centre frequency immediately below the Operating Channel.

The information shown in Table 54 shall be recorded in the test report.

Table 54: Information to be recorded in the test report for adjacent channel selectivity

Parameter	Notes
Center frequency	Nominal operating frequency tested (see Annex I)
Upper Adjacent Channel Selectivity value at $F_{nom} + OCW$ for S+3 dB	
Lower Adjacent Channel Selectivity value at $F_{nom} - OCW$ for S+3 dB	
Upper Adjacent Channel Selectivity value at $F_{nom} + OCW$ for S+23 dB	
Lower Adjacent Channel Selectivity value at $F_{nom} - OCW$ for S+23 dB	

5.5.3 Blocking and spurious response rejection

5.5.3.1 Test conditions

- 1) The measurement shall be performed on the EUT set to the nominal operating frequency (as per clause 5.2.1).
- 2) An EUT without a permanent or temporary antenna connector shall be tested according to clause 5.5.3.2.
- 3) An EUT with a permanent or temporary antenna connector shall be tested according to clause 5.5.3.3.

5.5.3.2 Radiated measurement

A test site selected from those described in clause B.2 according to clause B.7.

Signal generators A and B together with the combiner, shown in Figure 9, shall be placed outside the test site for full anechoic and semi anechoic rooms. For OATS, signal generators A and B with the combiner shall be on a table behind the transmit test antenna.

The output of the combiner shall be connected to a transmit test antenna. The transmit test antenna shall be placed in the test site.

The EUT shall be placed on the turntable at the orientation of the most sensitive position.

The measurements in clause 5.5.3.4 shall be performed using a radiated measurement method described in clause B.6.5.

5.5.3.3 Conducted measurement

Two signal generators A and B shall be connected to the EUT via a combining network as shown in Figure 10.

The measurements in clause 5.5.1.4 shall be performed.

5.5.3.4 Measurement procedure

Signal generator A shall be set to D-M3 test signal at the operating frequency of the EUT receiver modulated with a permitted test signal (as per clause 5.2.7, Table 24).

Step 1:

Signal generator B shall be powered off.

The level of signal generator A shall be set to the level that provides the reference sensitivity specified in Table 15. The output level of generator A shall then be increased by 3 dB.

Step 2:

- Signal generator B shall be unmodulated and set to operate is set to 1 MHz below the lower edge of the operating channel.
- Signal generator B level shall be adjusted until the wanted criteria (see clause 4.2.1) is no longer obtained or the limit specified in Table 18 is reached.
- With signal generator B settings unchanged, the receiver shall be replaced with a suitable RF power measuring equipment.
- The power into the measuring equipment shall be measured and noted. This can be measured on the EUT antenna connector for conducted test. For radiated measurements, the radiated level of signal generator B available at EUT is the signal generator B level - test site path loss at EUT position -path loss of combiner cables.

Step 3:

- The RF power measuring equipment shall be replaced with the EUT and the frequency of signal generator B adjusted by 5 kHz.

NOTE: The adjustment is intended only to estimate whether the frequency is a spurious response frequency. Adjustments by incrementing or decrementing the frequency value are equally valid.

- Signal generator B level shall be adjusted until the wanted criteria (see clause 4.2.1) is no longer obtained or the limit specified in Table 18 is reached.
- With signal generator B settings unchanged, the connection to the combiner shall be replaced with a connection to an RF power measuring equipment.
- The power into the measuring equipment shall be measured and noted. This can be measured on the EUT antenna connector for conducted test. For radiated measurements, the radiated level of signal generator B available at EUT is the signal generator B level - test site path loss at EUT position -path loss of combiner cables.
- If the two measured values
 - differ by > 10 dB then the receiver spurious response rejection level is the lower of the two measured power levels.

The information shown in Table 55 shall be recorded in the test report.

Table 55: Information recorded in the test report for spurious response rejection

Value	Notes
Test signal	The test signal used (see clause 5.2.7, Table 24)
Center frequency	Nominal operating frequency tested (see Annex I)
Wanted signal level	Measured power level of signal generator A
Spurious response frequency	Frequency of the lower measured value
Receiver spurious response rejection level	Lower of the two measured power levels

- differ by ≤ 10 dB then the higher of the two measurements is ignored:
 - The blocking level is the measured power level of signal generator B.
 - The information shown in Table 56 shall be recorded in the test report.

Table 56: Information recorded in the test report for blocking

Value	Notes
Test signal	The test signal used (see clause 5.2.7 Table 24)
Center frequency	Nominal operating frequency tested (see Annex I)
Blocking signal offset	See Table 18.
Blocking level	Blocking level Power level of signal generator B

Step 4:

- Signal generator B shall be powered off and reconnected to the combiner.
- The level of signal generator A shall be set to the level that provides the reference sensitivity specified in Table 15. The output level of generator A shall then be increased by 23 dB.
- The measurements in steps 2 and 3 are repeated.

Step 5:

- The measurement in steps 1 to 4 shall be repeated with the other frequency offsets given in clause 4.5.4.

5.5.4 Receiver maximum input signal level**5.5.4.1 Test conditions**

- 1) The EUT shall be operated according to the intended use on the nominal operating frequency (as per clause 5.2.1).
- 2) The measurements shall be performed for each data rate at which the EUT is able to operate.
- 3) An EUT without a permanent or temporary antenna connector shall be tested according to clause 5.5.4.2.
- 4) An EUT with a permanent or temporary antenna connector shall be tested according to clause 5.5.4.3.

5.5.4.2 Radiated measurement

A test site shall be selected from those described in clause B.7. The output of a signal generator shall be connected to a transmit test antenna with the same antenna polarization as the EUT. The transmit test antenna shall be placed in the test site. The EUT shall be placed on the turntable in the test site.

The measurements in clause 5.5.4.4 shall be performed using a radiated measurement method described in clause B.6.5.

5.5.4.3 Conducted measurement

The EUT shall be connected to the output of a signal generator. The measurements in clause 5.5.4.4 shall be performed.

5.5.4.4 Measurement procedure

Step 1:

- The signal generator, modulated with a permitted test signal (see Table 24), shall be set to the nominal operating frequency (see clause 5.2.1).
- The EUT shall be set to operate on the nominal operating frequency.
- The minimum wanted signal level shall be set to the level that provides the reference sensitivity specified in Table 15 increased by 3 dB.

Step 2:

- The EUT shall be started as a receiver.

Step 3:

- The level of the input signal to the EUT shall be increased until the wanted criteria (see clause 4.2.1) is no longer obtained or the limit specified in Table 19 is reached.

Step 4:

- With the signal generator settings unchanged, the output of the signal generator shall be connected to an RF power measuring equipment.
- For a conducted test: the power into the measuring equipment shall be measured.
- For a radiated test: the power into the measuring equipment plus the gain of the test antenna minus cables losses shall be measured.

The information shown in Table 57 shall be recorded in the test report.

Table 57: Information recorded in the test report for maximum input signal level

Value	Notes
Test signal	The test signal used (see clause 5.2.7, Table 24)
Data rate	EUT data rate
Operating frequency	Nominal operating frequency tested (see Annex I)
Maximum input signal	Measured power level

Step 5:

- Steps 1 to 4 shall be repeated for each data rate at which the EUT is able to operate.

5.6 Conformance test suites for functional requirements

5.6.1 General test conditions

It is not the intention of test suites for functional requirements to test the link between the EUT and other equipment. Equipment placement and operating parameters should be set to provide adequately reliable exchange of data between the devices for the purpose of the test.

Any necessary companion equipment, together with operating software and instructions, for the EUT intended use should be provided.

Test suites for functional requirements may require observation of EUT behaviour specific to the implemented protocols used in the data network. Consequently, a protocol analyser able to receive and interpret the specific protocols used by the EUT may be necessary for such observations.

Functional tests verify that equipment in data networks perform required functions and, if applicable, that the actions are performed within specified time limits.

5.6.2 Network access point

5.6.2.1 Test conditions

- 1) The measurement shall be performed over the permitted frequency band defined in Table E.1 or Table F.1.
- 2) This test is performed with:
 - a) Analyser A - a protocol analyser able to receive and interpret radio transmissions between the EUT and nodes in the data network.
 - b) Analyser B - a protocol analyser able to receive and interpret transmissions between the EUT and the external network or service.

The EUT shall be configured to operate in a manner representative of its intended use.

5.6.2.2 Measurement Procedure

Figure 11 illustrates the measurement set up.

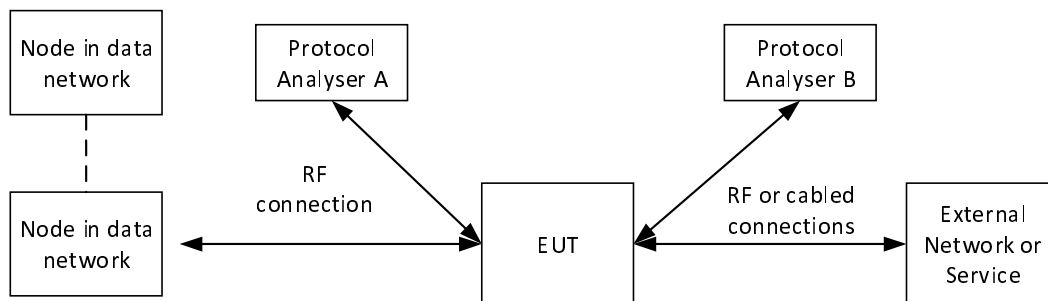

Figure 11: Network access point analyser arrangement

Step 1:

For conducted measurements, the EUT shall be connected to analyser B.

Analyser A and analyser B shall be set to record all traffic.

Table 58: Test parameters settings for NAP observations

Setting	Value	Notes
Background observation period	60 minutes	Period to capture background traffic from data network and external network or service
NAP response period	< NAP message transit delay	Period to capture NAP response to requests

The EUT and all necessary companion equipment shall be set to operate in a normal manner for their intended use with a permitted test signal (see clause 5.2.7, Table 23). Traffic shall be recorded by both analysers over the background observation period defined in Table 58.

The captured traffic shall be saved and traffic capture on the two analysers restarted.

Step 2:

A request to transfer information from a node within the data network to the external network or service shall be generated.

NOTE 1: The means to generate such information is outside the scope of the present document.

The traffic recorded by both analysers over the NAP response period defined in Table 58 shall be saved and traffic capture on the two analysers restarted.

Step 3:

A request to transfer information from the external network or service to a node within the data network shall be generated.

NOTE 2: The means to generate such information is outside the scope of the present document.

The traffic recorded by both analysers over the NAP response period shall be saved.

Step 4:

Ignoring equivalent traffic to that recorded in Step 1:

- The saved traffic from step 2 shall be analysed to identify the generated request and any following response by the EUT on the link to the external network or service.
- The saved traffic from step 3 is analysed to identify the generated request and any following response by the EUT into the data network.

The information in Table 59 is recorded in the test report.

Table 59: Information to be recorded in the test report for NAP

Parameter	Value recorded in the test report
NAP response to data network request	Whether the NAP responded to a request from within the data network to the external network or service
NAP response to external network or service request	Whether the NAP responded to a request from the external network or service to the data network

The pass criterion is that at least one NAP response shall be observed.

5.6.3 Under the control of a Master NAP

5.6.3.1 Test conditions

- 1) The measurement shall be performed over the applicable permitted frequency band defined in Table E.1 or Table F.1.
- 2) This test is performed using a power sensing equipment suitable for measurements at 800 MHz to 920 MHz. The test equipment shall be capable of producing 100 K samples/second to provide 10 µs resolution.
- 3) The EUT shall be configured to operate in a manner representative of its intended use.
- 4) An EUT with a permanent or temporary antenna connector shall be tested according to clause 5.6.3.2.
- 5) An EUT without a permanent or temporary antenna connector shall be tested according to clause 5.6.3.3.

5.6.3.2 Radiated measurement

A test site shall be selected from those described in clause B.2 according to clause B.7 and the measurements in clause 5.6.4.3 shall be performed using the corresponding radiated measurement procedure described in clause B.6. The measurement set up is shown in Figure 12.

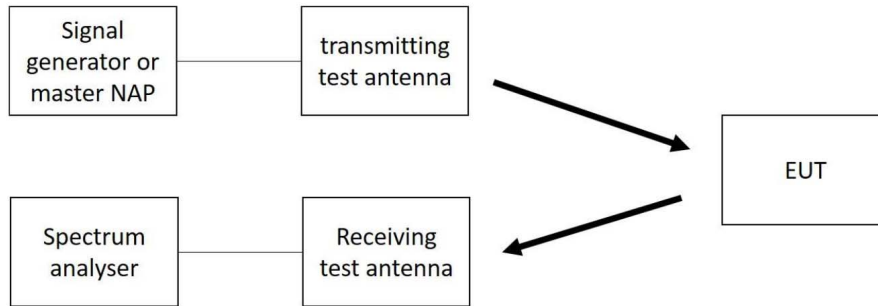

Figure 12: Set up for the under control of a master NAP requirement - radiated measurement

5.6.3.3 Conducted measurement

The measurements in clause 5.6.3.4 shall be performed. The measurement set up is shown in Figure 13.

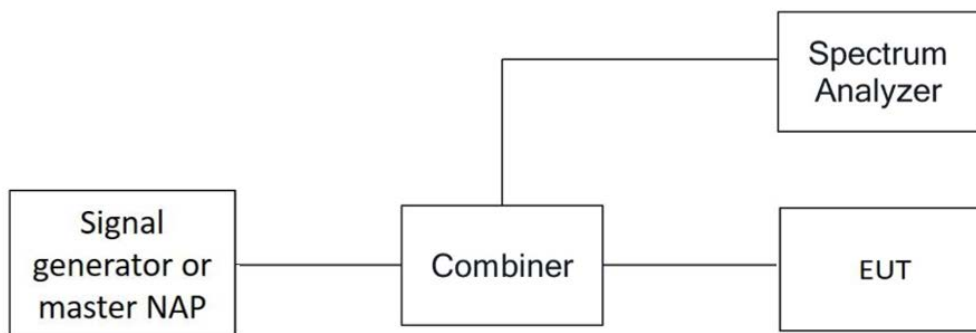

Figure 13: Set up for the under control of a master NAP requirement - conducted measurement

5.6.3.4 Measurement procedure

The power sensing equipment shall be configured for the parameters specified in Table 60.

Table 60: Test parameters settings for the requirement under the control of a Master NAP

Setting	Value	Notes
Sample rate	≥ 100 K samples/second	Sampling rate for at least 10 μ s resolution
Trigger	-	Trigger setting to capture leading edge of first transmission
Observation period	one hour	Observation time to sample power in the observation bandwidth
Observation Band	Permitted frequency band (see Table E.1 and Table F.1)	Bandwidth within which power measurements are made
Frequency	Center frequency of the permitted frequency band (see Table E.1 and Table F.1)	

Step 1:

The EUT shall be set to operate with a signal representative of its intended use.

Step 2:

Turn on the signal generator or the master NAP in a manner representative of its intended use. The output power level of the signal generator or master NAP shall be set to achieve 20 dB above the receiver sensitivity limit at the EUT (see clause 5.5.1).

Step 3:

The power sensing equipment shall be used to sample the power in the observation bandwidth for the observation period. The presence of any transmission from the EUT above -75 dBm detected by the power sensing equipment shall be noted.

NOTE 1: The EUT should transmit as intended.

Step 4:

Turn off the signal generator or the master NAP, to ensure that no signal is transmitted to EUT for a duration of one hour.

Step 5:

The power sensing equipment shall be used to sample power in the observation bandwidth for the observation period. The observation period shall start after one hour has expired.

The presence of any transmission from the EUT above -75 dBm detected by the spectrum analyser during the observation period shall be noted.

NOTE 2: After the master NAP was switched off the EUT should switch off as well at latest after 1 hour.

The information shown in Table 61 shall be recorded in the test report.

Table 61: Information to be recorded in the test report for the requirement under the control of a Master NAP

Value	Notes
Observation band	The frequency band within which power measurements are made
Number of transmissions detected 1	Number of transmissions detected when the Master NAP/signal generator is on (step 3)
Number of transmissions detected 2	Number of transmissions detected when the Master NAP/signal generator is off (step 5)

5.6.4 Master NAP

5.6.4.1 Test conditions

- 1) The measurement shall be performed over the applicable permitted frequency band defined in Table E.1 or Table F.1.
- 2) This test is performed using a power sensing equipment suitable for measurements at 800 MHz to 920 MHz. The power sensing equipment shall be capable of producing 100 K samples/second to provide 10 µs resolution.
- 3) The EUT shall be configured to operate in a manner representative of its intended use.
- 4) The EUT shall be tested with a companion device.
- 5) The EUT shall be tested according to clause 5.6.4.2 for a companion device with a permanent or temporary antenna connector
- 6) The EUT shall be tested according to clause 5.6.4.3 for a companion device without a permanent or temporary antenna connector.

5.6.4.2 Radiated measurement

A test site shall be selected from those described in clause B.2 according to clause B.7 and the measurements in clause 5.6.4.3 shall be performed using the corresponding radiated measurement procedure described in clause B.6. The measurement set up is shown in Figure 14.

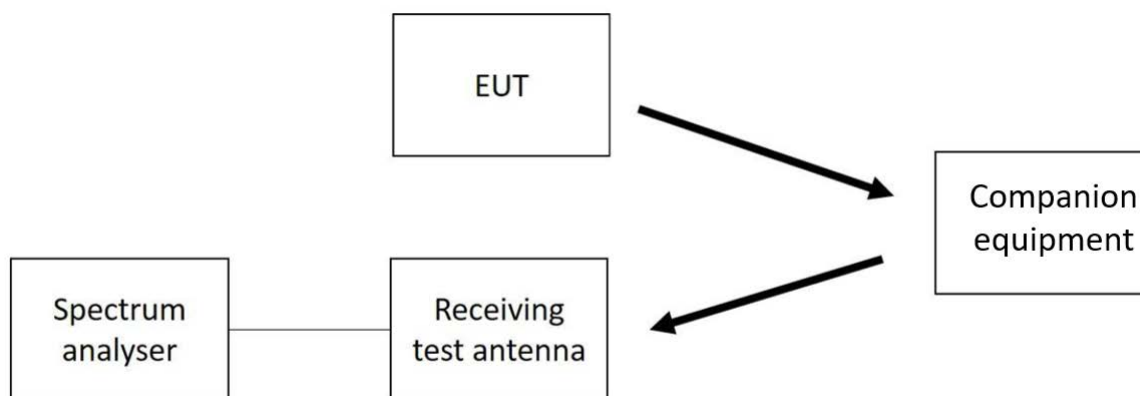

Figure 14: Set up for the master NAP requirement - radiated measurement

5.6.4.3 Conducted measurement

The measurements in clause 5.6.4.4 shall be performed. The measurement set up is shown in Figure 15.

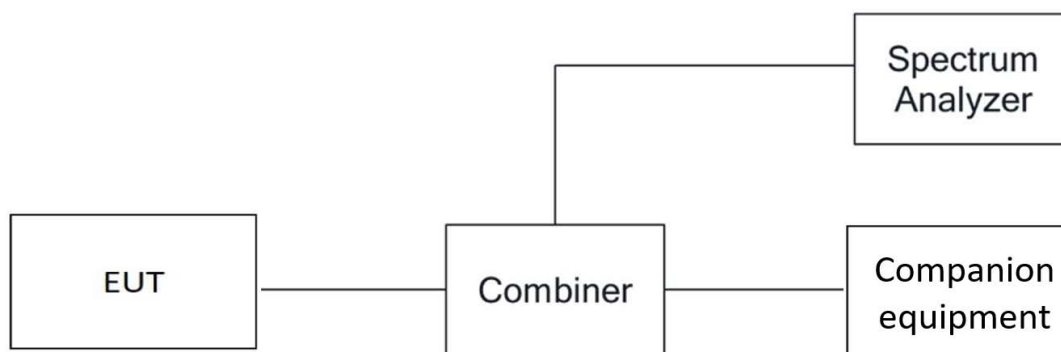

Figure 15: Set up for the master NAP requirement - conducted measurement

5.6.4.4 Measurement procedure

The power sensing equipment shall be configured for the parameters specified in Table 62.

Table 62: Test parameters settings for master NAP measurement

Setting	Value	Notes
Sample rate	$\geq 1\text{M}$ samples/second	Sampling rate for at least $1\ \mu\text{s}$ resolution
Trigger	-	Trigger setting to capture leading edge of first transmission
Frequency	Centre frequency of the permitted frequency band (see Table E.1 and Table F.1)	Centre frequency of the power measurement bandwidth
Bandwidth	Permitted frequency band (see Table E.1 and Table F.1)	Bandwidth within which power measurements are made
Observation time	1 hour	Duration of the measurements

Step 1:

The EUT shall be set to operate with a signal representative of its intended use. The EUT and the companion equipment shall be operated on the same operating frequency. The output power level of EUT shall be set to achieve 20 dB above the receiver sensitivity limit of the companion equipment (see clause 5.5.1).

Step 2:

Switch off the EUT to ensure that no signal is transmitted to the companion equipment for a duration of one hour.

Step 3:

The power sensing equipment shall be used to sample power in the observation bandwidth for the observation period. The observation period shall start after one hour has expired. The presence of any transmission from the companion device above -75 dBm detected by the spectrum analyser during the observation period shall be noted.

The information shown in Table 63 shall be recorded in the test report.

Table 63: Information to be recorded in the test report for the requirement Master NAP

Value	Notes
Observation band	The frequency band within which power measurements are made
Number of transmissions detected	Number of transmissions detected during the observation period

5.7 Interpretation of the measurement results

The interpretation of the results recorded in the test report for the measurements described in the present document shall be as follows:

- the measured value related to the corresponding limit shall be used to decide whether an equipment meets the requirements of the present document;
- the value of the measurement uncertainty for the measurement of each parameter shall be separately included in the test report.

Annex G provides guidance on uncertainty values.

Annex A (informative): Relationship between the present document and the essential requirements of Directive 2014/53/EU

The present document has been prepared under the Commission's standardisation request C(2015) 5376 final [i.1] to provide one voluntary means of conforming to the essential requirements of Directive 2014/53/EU on the harmonisation of the laws of the Member States relating to the making available on the market of radio equipment and repealing Directive 1999/5/EC [i.2].

Once the present document is cited in the Official Journal of the European Union under that Directive, compliance with the normative clauses of the present document given in Table A.1 confers, within the limits of the scope of the present document, a presumption of conformity with the corresponding essential requirements of that Directive and associated EFTA regulations.

Table A.1: Relationship between the present document and the essential requirements of Directive 2014/53/EU

Harmonised Standard ETSI EN 303 659					
Requirement				Requirement Conditionality	
No	Description	Essential requirements of Directive	Clause(s) of the present document	U/C	Condition
1	Unwanted emissions in the spurious domain	3.2	4.3.1	U	
2	Effective radiated power	3.2	4.4.1	U	
3	Maximum occupied bandwidth	3.2	4.4.2	U	
4	Frequency error	3.2	4.4.3	U	
5	Transmitter Signal at the edges of the TxOFB	3.2	4.4.4	U	
6	Transient power	3.2	4.4.5	U	
7	Spectrum mask in the transmitter out-of-band domain	3.2	4.4.6	C	Applies to equipment with OCW > 25 kHz
8	Adjacent channel power	3.2	4.4.7	C	Applies to equipment with OCW ≤ 25 kHz.
9	Spectrum mask at permitted frequency band edges	3.2	4.4.8	U	
10	Duty cycle	3.2	4.4.9	U	
11	Adaptive power control	3.2	4.4.10	C	Applies only to equipment type 2, type 4, type 6, type 8, type 9, type 11, type 13, type 14
12	Transmitter behaviour under low-voltage conditions	3.2	4.4.11	C	Applies only to battery powered equipment
13	Receiver sensitivity	3.2	4.5.1	U	
14	Adjacent channel selectivity	3.2	4.5.2	U	
15	Spurious response rejection	3.2	4.5.3	U	
16	Blocking	3.2	4.5.4	U	
17	Receiver maximum input signal level	3.2	4.5.5	U	
18	Network access point	3.2	4.6.1	C	Applies only to equipment type 1, type 2, type 3, type 4
19	Under the control of a Master NAP	3.3	4.6.2	C	Applies only to equipment 7, type 9, type 12, type 14

Harmonised Standard ETSI EN 303 659					
Requirement				Requirement Conditionality	
No	Description	Essential requirements of Directive	Clause(s) of the present document	U/C	Condition
20	Master NAP	3.2	4.6.3	C	Applies only to equipment type 3, type 4

Key to columns:

Requirement:

No A unique identifier for one row of the table which may be used to identify a requirement.

Description A textual reference to the requirement.

Essential requirements of Directive

Identification of article(s) defining the requirement in the Directive.

Clause(s) of the present document

Identification of clause(s) defining the requirement in the present document unless another document is referenced explicitly.

Requirement Conditionality:

U/C Indicates whether the requirement is unconditionally applicable (U) or is conditional upon the manufacturer's claimed functionality of the equipment (C).

Condition Explains the conditions when the requirement is or is not applicable for a requirement which is classified "conditional".

Presumption of conformity stays valid only as long as a reference to the present document is maintained in the list published in the Official Journal of the European Union. Users of the present document should consult frequently the latest list published in the Official Journal of the European Union.

Other Union legislation may be applicable to the product(s) falling within the scope of the present document.

Annex B (normative): Test sites and arrangements for radiated measurement

B.1 Introduction

This annex and Annex C introduce three most commonly available test sites and a test fixture, to be used in the radiated measurements in accordance with the present document.

Subsequently the following items will be described:

- Open Area Test Site (OATS);
- Semi Anechoic Room (SAR);
- Fully Anechoic Room (FAR);
- Test fixture for relative measurements (see Annex C).

The first three are generally referred to as free field test sites. Both absolute and relative measurements can be performed on these sites. They are described in clause B.2. Clause B.3 describes the antennas used in these test sites. The test fixture can only be used for relative measurements and is described in Annex C.

Where absolute measurements are to be carried out, the test site should be verified. A detailed verification procedure is described in clause 6 of ETSI TR 102 273-4 [i.8] for the OATS, in clause 6 of ETSI TR 102 273-3 [i.9] for the SAR, and in clause 6 of ETSI TR 102 273-2 [i.10] for the FAR.

Information for calculating the measurement uncertainty of measurements on one of these test sites can be found in ETSI TR 100 028-1 [i.11] and ETSI TR 100 028-2 [i.11], ETSI TR 102 273-2 [i.10], ETSI TR 102 273-3 [i.9] and ETSI TR 102 273-4 [i.8].

B.2 Radiation test sites

B.2.1 Open Area Test Site

An OATS comprises a turntable at one end and an antenna mast of variable height at the other end above a ground plane which, in the ideal case, is perfectly conducting and of infinite extent. In practice, while good conductivity can be achieved, the ground plane size has to be limited. A typical Open Area Test Site is shown in Figure B.1.

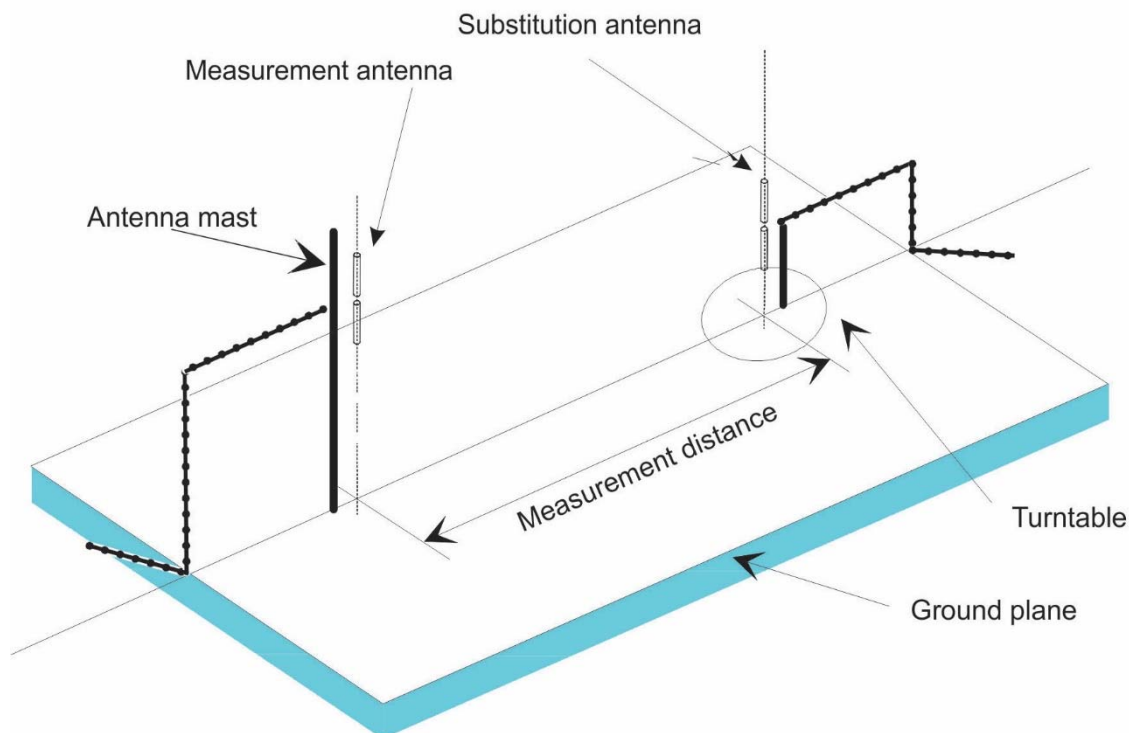

Figure B.1: A typical Open Area Test Site

The ground plane creates a wanted reflection path, such that the signal received by the receiving antenna is the sum of the signals received from the direct and reflected transmission paths. The phasing of these two signals creates a unique received level for each height of the transmitting antenna (or EUT) and the receiving antenna above the ground plane.

The antenna mast provides a variable height facility (from 1 m to 4 m) so that the position of the measurement antenna can be optimized for maximum coupled signal between antennas or between a EUT and the measurement antenna.

A turntable is capable of rotation through 360° in the horizontal plane and it is used to support the test sample (EUT) at a specified height, usually 1,5 m above the ground plane.

The measurement distance and minimum chamber dimensions can be found in clause B.2.4. The distance used in actual measurements shall be recorded with the test results.

Further information on Open Area Test Sites can be found in ETSI TR 102 273-4 [i.8].

B.2.2 Semi Anechoic Room

A SAR - or anechoic chamber with a conductive ground plane - is an enclosure, usually shielded, whose internal walls and ceiling are covered with radio absorbing material. The floor, which is metallic, is not covered by absorbing material and forms the ground plane. The chamber usually contains an antenna mast at one end and a turntable at the other end. A typical anechoic chamber with a conductive ground plane is shown in Figure B.2.

This type of test chamber attempts to simulate an ideal OATS, whose primary characteristic is a perfectly conducting ground plane of infinite extent.

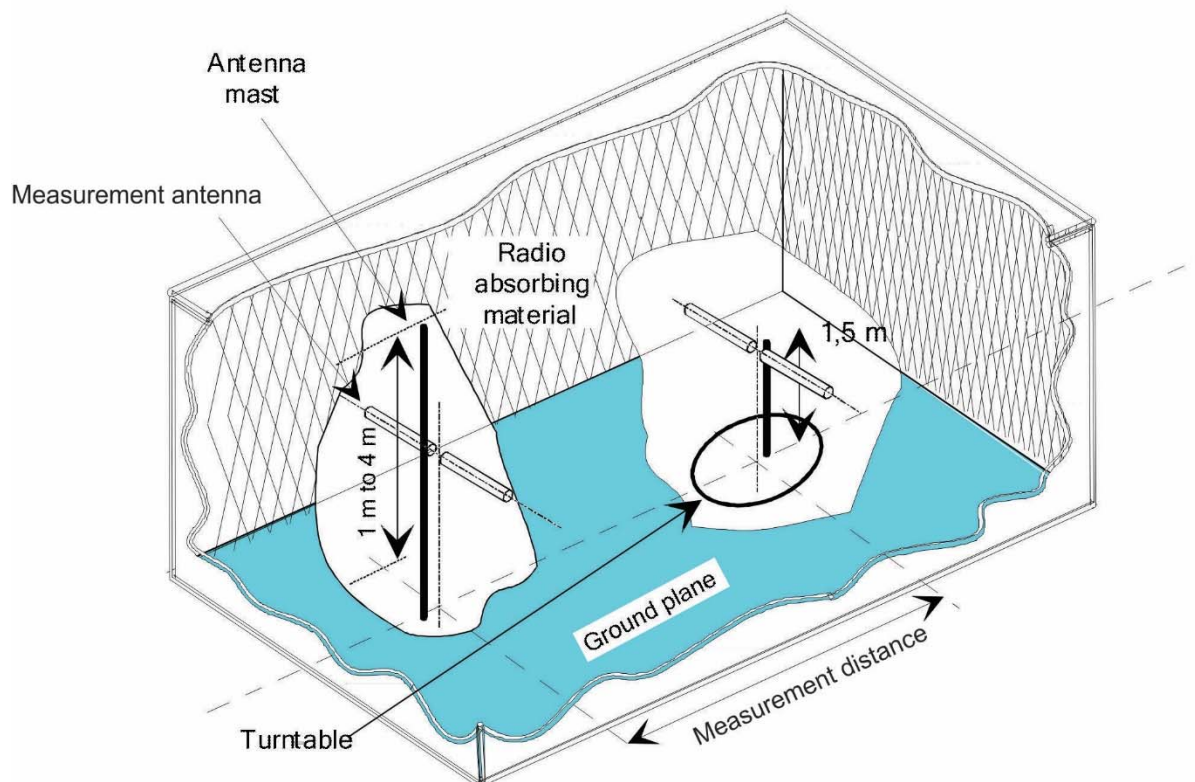

Figure B.2: A typical Semi Anechoic Room

In this facility the ground plane creates a wanted reflection path, such that the signal received by the receiving antenna is the sum of the signals received from the direct and reflected transmission paths. The phasing of these two signals creates a unique received level for each height of the transmitting antenna (or EUT) and the receiving antenna above the ground plane.

The antenna mast provides a variable height facility (from 1 m to 4 m) so that the position of the measurement antenna can be optimized for maximum coupled signal between antennas or between a EUT and the measurement antenna.

A turntable is capable of rotation through 360° in the horizontal plane and it is used to support the test sample (EUT) at a specified height, usually 1,5 m above the ground plane.

The measurement distance can be found in clause B.2.4. The distance used in actual measurements shall be recorded with the test results.

Further information on Semi Anechoic Rooms can be found in ETSI TR 102 273-3 [i.9].

B.2.3 Fully Anechoic Room

A FAR is an enclosure, usually shielded, whose internal walls, floor and ceiling are covered with radio absorbing material. The chamber usually contains an antenna support at one end and a turntable at the other end. A typical FAR is shown in Figure B.3.

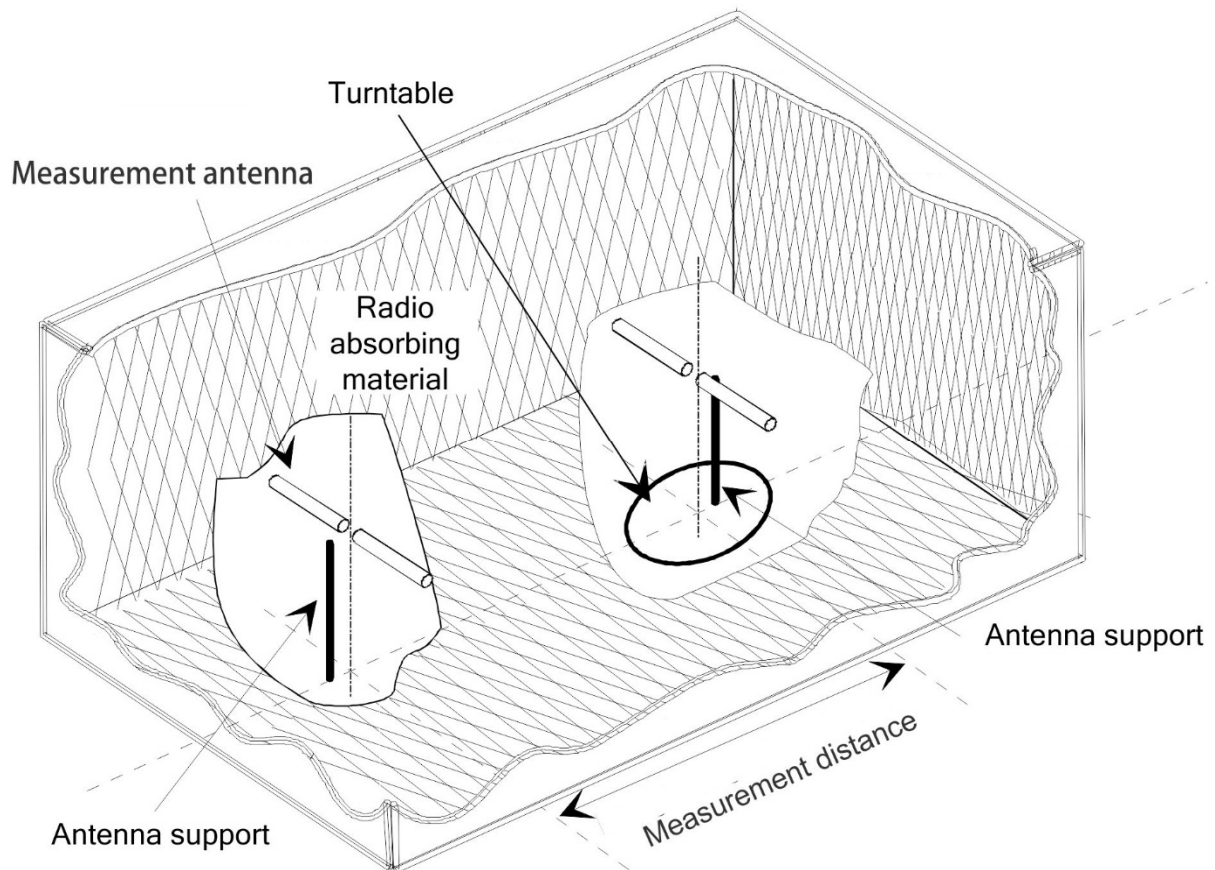

Figure B.3: A typical Fully Anechoic Room

The chamber shielding and radio absorbing material work together to provide a controlled environment for testing purposes. This type of test chamber attempts to simulate free space conditions.

The shielding provides a test space, with reduced levels of interference from ambient signals and other outside effects, whilst the radio absorbing material minimizes unwanted reflections from the walls and ceiling which can influence the measurements. The shielding should be sufficient to eliminate interference from the external environment that would mask any signals that have to be measured.

A turntable is capable of rotation through 360° in the horizontal plane and it is used to support the EUT at as close as possible to a height of 1,5 m above the ground plane.

Equipment which is intended to be worn on a person may be tested using a simulated man as support. The simulated man comprises a rotatable acrylic tube, placed on the ground.

The tube shall have the following dimensions:

- Height: $1,7 \pm 0,1$ m;
- Inside diameter: 300 ± 5 mm;
- Sidewall thickness: $5 \pm 0,5$ mm.

The tube shall be filled with a salt (NaCl) solution of 1,5 g per litre of distilled water.

The equipment shall be fixed to the surface of the simulated man, at the appropriate height for the equipment.

NOTE: To reduce the weight of the simulated man it may be possible to use an alternative tube which has a hollow centre of 220 mm maximum diameter.

The measurement distance can be found in clause B.2.4. The distance used in actual measurements shall be recorded with the test results.

Further information on Fully Anechoic Rooms can be found in ETSI TR 102 273-2 [i.10].

B.2.4 Measurement Distance

The measurement distance should be chosen in order to measure the EUT at far-field conditions. The minimum measurement distance between the equipment and the measurement antenna should be λ or $r_m \gg \frac{D^2}{\lambda}$, whichever is the greater.

λ = wavelength in m

r_m = minimum measurement distance between EUT and measurement antenna in m

D = largest dimension of physical aperture of the largest antenna in the measurement setup, in m

D^2/λ = distance between outer boundary of radiated near field (Fresnel region) and inner boundary of the radiated far-field (Fraunhofer region) in m, also known as Rayleigh distance

3 m or 10 m are recommended measurement distances, where these conditions cannot be fulfilled, and where the measurement distance would result in measurements in the near field (e.g. while measuring spurious emissions), this should be noted in the test report and the additional measurement uncertainty should be incorporated into the results. The measurement distance may also be dependent on the EUT size (e.g. 3 m distance when an EUT is mounted on/in a car is not allowed because EUT is exceeding the quiet zone of the test site.)

B.3 Antennas

B.3.1 General considerations

Antennas are needed for the radiated measurements on the three test sites described in clause B.2. Depending on its use, the antenna will be designated as "measurement antenna" (see clause B.3.2) or "substitution antenna" (see clause B.3.3).

B.3.2 Measurement antenna

In emission tests the measurement antenna is used to detect the field from the EUT in one stage of the measurement, and from the substitution antenna in the other stage. When the test site is used for the measurement of receiver characteristics, the antenna is used as the transmitting equipment.

The measurement antenna should be mounted on a support capable of allowing the antenna to be used in either horizontal or vertical polarization. Additionally, on an OATS or SAR, the height of the centre of the antenna above the ground should be variable over the specified range 1 m to 4 m. In the frequency band 30 MHz to 1 000 MHz, biconical or Logarithmic Periodic Dipole Antennas (LPDAs) are recommended. Above 1 GHz, horn antennas or logarithmic periodic dipole antennas are recommended.

For spurious emission testing, however, a combination of biconical antennas (commonly termed "bicones") and log periodic dipole array antennas (commonly termed "log periodics") could be used to cover the entire 30 MHz to 1 000 MHz band.

The measurement antenna does not require an absolute calibration unless a substitution method is used.

B.3.3 Substitution antenna

The substitution antenna shall be used to replace the EUT in substitution measurements.

The substitution antenna shall be suitable for the frequency range and the return loss of the antenna shall be taken into account when calculating the measurement uncertainty.

The phase centre of this substitution antenna shall coincide with the reference point of the test sample it has replaced. Therefore, antenna with a phase centre that changes as a function of frequency are not suitable as a substitution antenna.

The reference point of the substitution antenna shall coincide with the volume centre of the EUT when its antenna is internal, or the point where an external antenna is connected to the EUT.

The distance between the lower extremity of the antenna and the ground shall be at least 30 cm.

The substitution antenna shall be calibrated. For below 1 GHz, the calibration is relative to a half wave dipole, while above 1 GHz, an isotropic radiator is the reference.

NOTE: Calibration figures intended for use above a reflective surface cannot be used in an anechoic chamber or vice versa.

B.4 Guidance on the use of radiation test sites

B.4.1 General considerations

This clause details procedures, test equipment arrangements and verification that should be carried out before any of the radiated test are undertaken. These schemes are common to all types of test sites described in clause B.2.

Where necessary, a mounting bracket of minimal size should be available for mounting the EUT on the turntable. This bracket should be made from low conductivity, low relative permittivity (i.e. $\frac{\epsilon}{\epsilon_0} < 1,5$) material(s) such as expanded polystyrene, balsawood, etc.

B.4.2 Power supplies for the battery powered EUT

All tests should be performed using power supplies wherever possible, including tests on EUT designed for battery-only use. For battery powered equipment, power leads should be connected to the EUT's supply terminals (and monitored with a digital voltmeter) but the battery should remain present, electrically isolated from the rest of the equipment, possibly by putting tape over its contacts.

The presence of these power cables can, however, affect the measured performance of the EUT. For this reason, they should be made to be "transparent" as far as the testing is concerned. This can be achieved by routing them away from the EUT and directing them either to the screen or to the ground plane by the shortest possible paths. Power cables shall be equipped with ferrite immediately at EUT. Ferrite bead shall present an impedance of at least 100 Ω at 100 MHz.

B.4.3 Site preparation

The cables to the measuring and substitution antenna should be routed horizontally away from the testing area for a minimum of 2 m (unless, in the case both types of anechoic chamber, a back wall is reached) and then allowed to drop vertically and out through either the ground plane or screen (as appropriate) to the test equipment. Precautions should be taken to minimize pick up on these leads. The cables, their routing and dressing should be identical to the verification set-up.

NOTE: For ground reflection test sites (i.e. anechoic chambers with ground planes and Open Area Test Sites) which incorporate a cable drum with the antenna mast, the 2 m requirement may be impossible to comply with.

Calibration data for all items of test equipment should be available and valid. For test, substitution and measuring antennas, the data should include gain relative to an isotropic radiator (or antenna factor) for the frequency of test. Also, the VSWR of the substitution and measuring antennas should be known.

The calibration data on all cables and attenuators should include insertion loss and VSWR throughout the entire frequency range of the tests. All VSWR and insertion loss figures should be recorded in the log book results sheet for the specific test.

Where correction factors/tables are required, these should be immediately available.

B.5 Coupling of signals

B.5.1 General considerations

The presence of leads in the radiated field may cause a disturbance of that field and lead to additional measurement uncertainty. These disturbances can be minimized by using suitable coupling methods, offering signal isolation and minimum field disturbance (e.g. optical coupling).

B.5.2 Data Signals

Isolation can be provided by the use of optical, ultrasonic or infra-red means. Field disturbance can be minimized by using a suitable fibre optic connection. Ultrasonic or infra-red radiated connections require suitable measures for the minimization of ambient noise.

B.6 Measurement procedures for radiated measurement

B.6.1 General considerations

This annex gives the general procedures for radiated measurements using the test sites and arrangements described in clause B.2.

B.6.2 Radiated measurements in an OATS or SAR

Radiated measurements shall be performed with the aid of a measurement antenna and a substitution antenna described in clause B.3, in test sites described in clauses B.2.1 and B.2.2. The EUT and the measurement antenna shall be oriented such as to obtain the maximum emitted power level. This position shall be recorded in the measurement report:

- 1) The measurement antenna (equipment 2 in Figure B.4) shall be oriented initially for vertical polarization unless otherwise stated and the EUT (equipment 1 in Figure B.4) shall be placed on the support in its standard position and switched on.
- 2) The measurement equipment (equipment 3 in Figure B.4) shall be connected to the measurement antenna and set-up according to the specifications of the test.

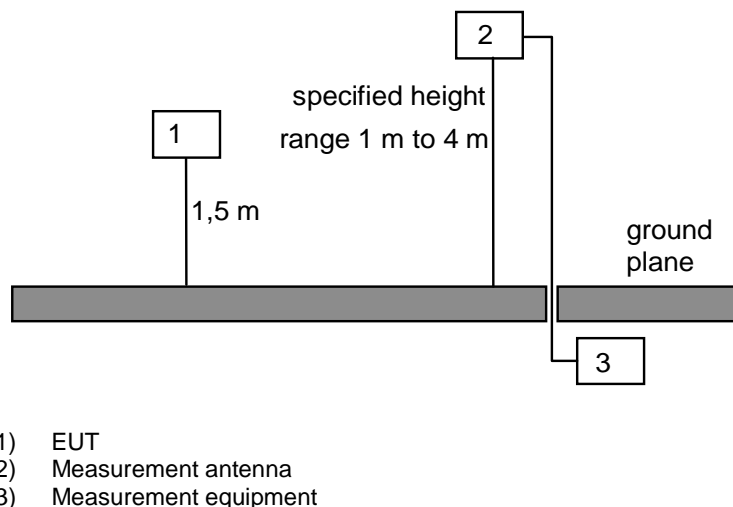

Figure B.4: Measurement arrangement No.1

- 3) The EUT shall be rotated through 360° in a horizontal plane until a maximum signal is received at the measurement equipment.
- 4) The measurement antenna shall be raised or lowered again through the specified height range until a maximum is obtained at the measurement equipment. This level shall be recorded.
- 5) The measurement shall be repeated with the measurement antenna oriented for horizontal polarization.

NOTE: This maximum may be a lower value than the value obtainable at heights outside the specified limits.

B.6.3 Radiated measurements in a FAR

For radiated measurements using a FAR, the procedure is identical to the one described in clause B.6.2, except that the height scan is omitted.

B.6.4 Substitution measurement

To determine the absolute measurement value a substitution measurement is performed. The following steps shall be performed:

- 1) Replace the EUT, depicted as equipment 1 in Figure B.4, with a substitution antenna oriented for vertical polarization.
- 2) Connect a calibrated signal generator to the substitution antenna and adjust it to the measurement frequency.
- 3) When an OATS or a SAR is used, the measurement antenna shall be raised or lowered, to ensure that the maximum signal is received at the measurement equipment.
- 4) Subsequently, the power of the signal generator shall be adjusted until the level obtained at the measurement equipment is the same as with the EUT.
- 5) The absolute radiated power is equal to the power supplied by the signal generator, increased by the substitution antenna gain minus the cable losses (the values of cable losses and antenna gain values in dB).
- 6) This measurement shall be repeated with the substitution antenna oriented for horizontal polarization.

NOTE: For test sites with a fixed setup of the measurement antenna(es) and a reproducible positioning of the EUT, correction values from a verified site calibration can be used alternatively.

B.6.5 Radiated measurement methods for receivers

Measurements on receiving equipment are essentially the reverse of measurements on transmitters, with a signal generator connected to the measuring antenna. Calibration relies on the principle of replacing the EUT with a substitution antenna and suitable measuring equipment.

Clause B.3.3 "Substitution antenna" applies.

NOTE 1: This does not require an actual half wave dipole, only an antenna with known gain relative to a half wave dipole.

There are two measurement methods:

- a) Connect the substitution antenna to a calibrated measuring receiver and read the measurement result directly.
- b) Measure the path loss from the measurement antenna to the substitution antenna and subtract this, from the signal generator level to obtain the measurement result.

NOTE 2: For method a), the level received in some measurements is likely to be too low, so it may be necessary to raise the signal generator by a suitable amount and apply an equivalent offset to the measurement result.

NOTE 3: Method b) means that one calibration measurement can be used for multiple tests.

B.7 Guidance for testing technical requirements

B.7.1 General

This clause provides guidance on how the various technical requirements can be verified using radiated measurements.

B.7.2 Radio test suites and corresponding test sites

Table B.1 provides guidance on the test site to be used for each of the radio tests when performing radiated measurements on integral antenna equipment.

Table B.1: Radio conformance tests and corresponding test sites

Radio conformance test - Clause number	Small size EUT (note 1) corresponding test site - Clause number(s)	Medium size EUT (note 2) corresponding test site - Clause number(s)	Large size EUT (note 3) corresponding test site - Clause number(s)
5.3	B.2.3 (FAR)	B.2.2 (SAR)	B.2.1 (OATS)
5.4	B.2.3 (FAR)	B.2.2 (SAR)	B.2.1 (OATS)
5.5	B.2.3 (FAR)	B.2.2 (SAR)	B.2.1 (OATS)
5.6	B.2.3 (FAR)	B.2.2 (SAR)	B.2.1 (OATS)
Additional condition	If B.2.3 test site (FAR) is not available, B.2.2 (SAR) shall be used instead, but measurements may be influenced by the ground plane reflections. A specific calibration of path loss is required.	If B.2.2 test site (SAR) is not available, B.2.1 (OATS) shall be used instead, but measurements may be influenced by the ground plane reflections. A specific calibration of path loss is required.	
NOTE 1: The maximum dimension excluding leads shall be less than 1,5 m for small size EUT.			
NOTE 2: The maximum dimension excluding leads shall be equal to or larger than 1,5 m and less than 2,5 m for medium size EUT.			
NOTE 3: At least one dimension excluding leads shall be equal to or larger than 2,5 m for large size EUT.			

Annex C (normative): Test Fixture

C.1 Description of test-fixture

With equipment intended for use with an integral antenna, and not equipped with a 50 Ω RF output connector, a suitable test fixture as shown in Figure C.1 shall be used.

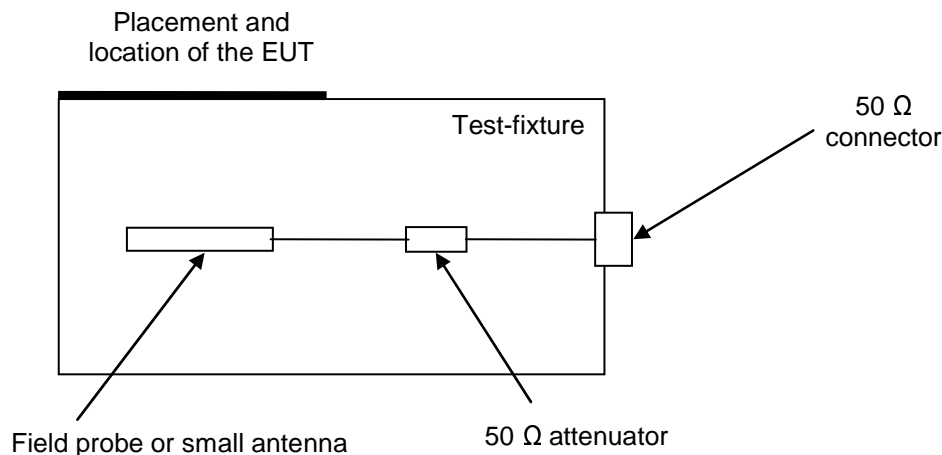

Figure C.1: Test fixture

Where a test fixture as defined in the present clause is used for measurements on integral antenna equipment, tests on radiated signals shall be carried out using the test fixture.

The test fixture is a radio frequency device for coupling the integral antenna to a 50 Ω RF terminal at all frequencies for which measurements need to be performed.

In addition, the test fixture may provide:

- a) a connection to an external power supply;
- b) a method to provide the input to or output from the equipment.

NOTE: This may include coupling to or from the antenna. The test fixture could also provide the suitable coupling means e.g. for data or video outputs.

The performance characteristics of the test fixture shall conform to the following basic parameters:

- a) the coupling loss shall not be greater than 30 dB;
- b) a coupling loss variation over the frequency range used in the measurement which does not exceed 2 dB under all test conditions;
- c) circuitry associated with the RF coupling shall contain no active or non-linear components;
- d) the VSWR at the 50 Ω socket shall not be more than 1,5 over the frequency range of the measurements;
- e) the coupling loss shall be independent of the position of the test fixture and be unaffected by the proximity of surrounding objects or people. The coupling loss shall be reproducible when the equipment under test is removed and replaced. Normally, the test fixture is in a fixed position and provides a location for the EUT;

The attenuation of the test fixture coupling should be such that the received signal at the measuring instrument is at least 10 dB above the measuring instrument noise floor. If the attenuation is too great it can be compensated by linear amplification outside the test-fixture.

The characteristics and validation shall be included in the test report.

C.2 Validation of the test-fixture in the temperature chamber

The following is an example test fixture validation procedure to be followed if test fixture measurements are performed under extreme temperature conditions. Other validation procedures may be used.

A description of the validation procedure used shall be included in the test report.

The test fixture is brought into a temperature chamber.

Step 1:

As shown in Figure C.2, a transmit antenna connected to a signal generator shall be positioned from the test-fixture at a far field distance of not less than one λ at the frequency. The test fixture consists of the mechanical support for the EUT, an antenna or field probe and a 50 Ω attenuator for proper termination of the field probe. The test fixture shall be connected to a spectrum analyser via the 50 Ω connector.

The signal generator shall be set to operate on the nominal operating frequency of the EUT. The unmodulated output power of the signal generator shall be set to a value such that a sufficiently high level can be observed with the spectrum analyser. This value shall be recorded in the test report. The signal generator shall then be set to the upper and the lower band limit of the EUT's permitted frequency band (see Table 12). The measured values shall not deviate more than 1 dB from the value at the nominal operating frequency. The distance between test antenna and test fixture may be reduced to $\lambda/2$ for frequencies below 100 MHz.

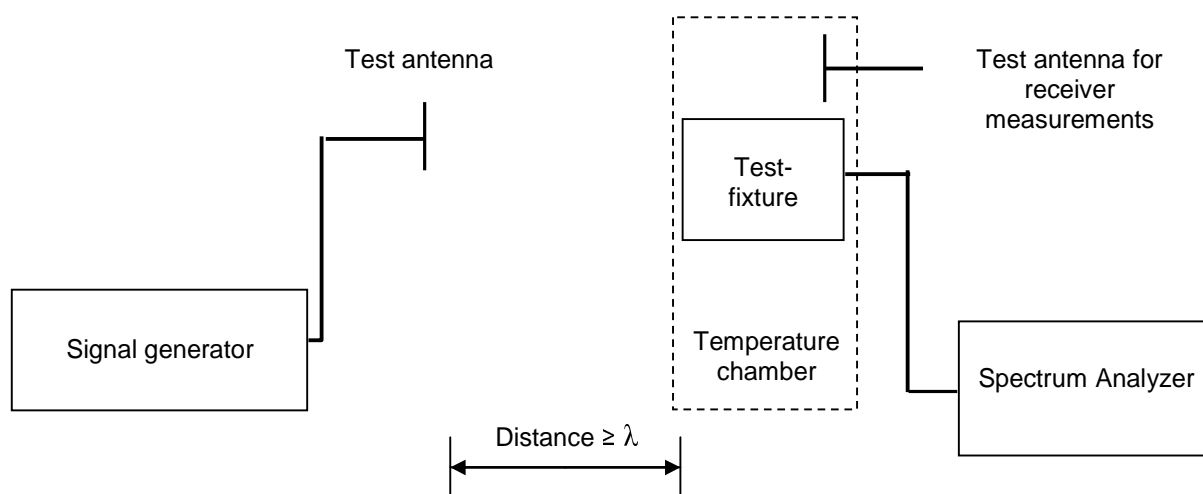

Figure C.2: Validation of test set-up without EUT

Step 2:

During validation and testing the EUT shall be fitted to the test fixture in a switched-off mode as shown in Figure C.3. Step 1 shall be repeated, this time with the EUT in place. The measured values shall be compared with those from step 1 and may not vary by more than 2 dB. This shows that the EUT does not cause any significant shadowing of the radiated power.

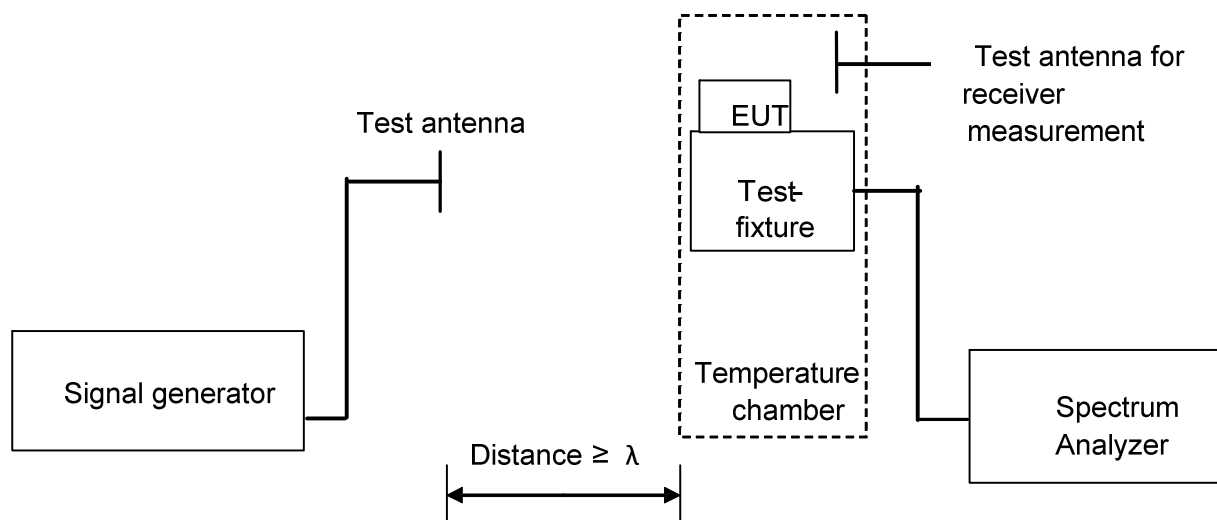

Figure C.3: Validation of test set-up with EUT in place

Step 3:

In the case of a battery operated EUT that is supplied by a temporary voltage feed, a decoupling filter shall be installed directly at the EUT in order to avoid parasitic electromagnetic radiation. See Figure C.4.

In this step the signal generator and the transmit antenna are removed.

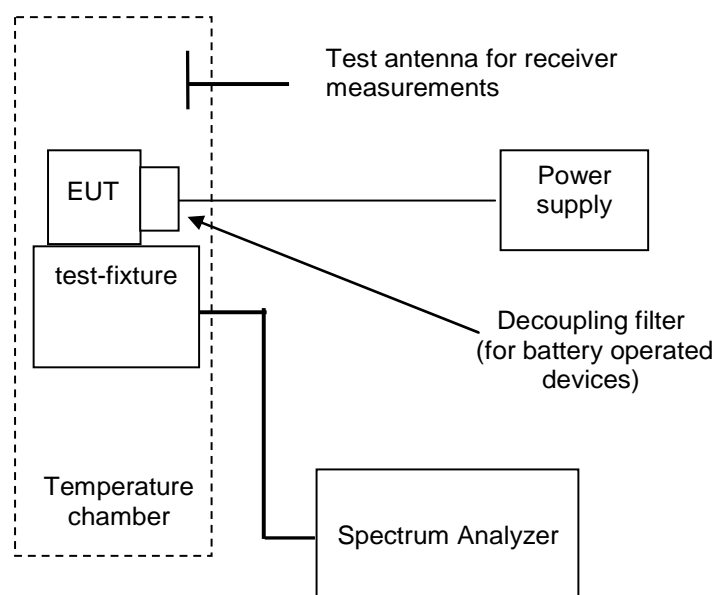

Figure C.4: Test of EUT

C.3 Mode of use

The test fixture may be used to facilitate some of the transmitter and receiver measurements in the case of equipment having an integral antenna. See clause 5.2.7 for guidance on applicable use of the test fixture in conformance methods of measurement for the present document.

Annex D (normative): T_{On} measurements

D.1 Measurement procedure

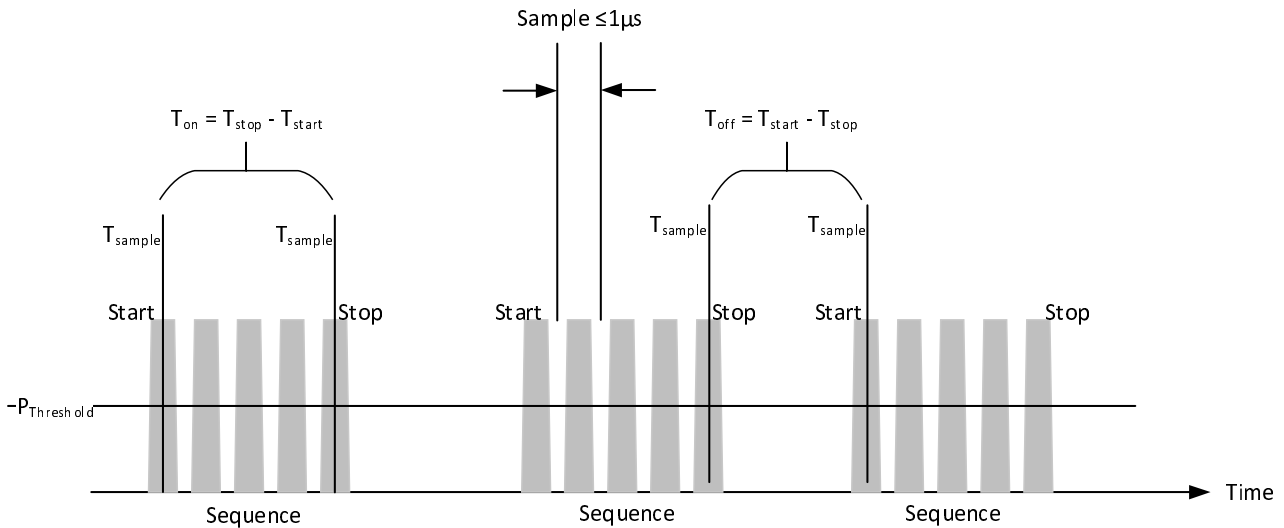

Figure D.1: Power samples reference timing

The start time and stop time of each sequence of samples above $P_{\text{Threshold}}$ shall be determined. The timing reference for samples shall be as shown in Figure D.1. The T_{On} shall be calculated from the difference between the time of the first and last samples of the sequence. The start time, stop time and T_{On} for each sequence shall be saved.

Between the saved stop and start times of two adjacent sequences, the T_{Off} shall be calculated. These T_{Off} values shall be saved.

D.2 T_{disregard} procedure

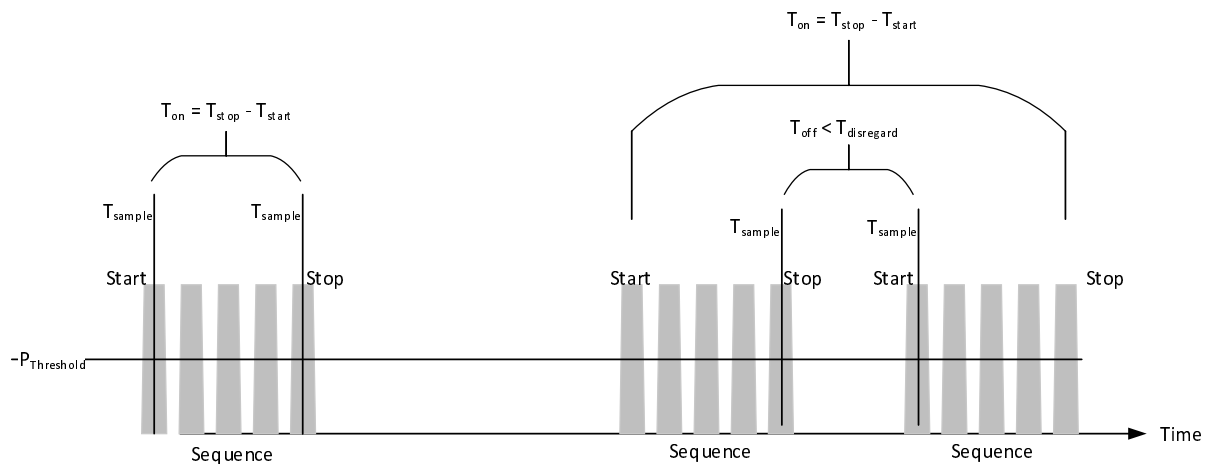

Figure D.2: T_{disregard}

Within the calculated T_{Off} , for each period of time less than $T_{\text{disregard}}$ (see Annex I) the preceding sequence and the following sequence shall be merged with the T_{Off} and shall be replaced with the resulting combined start, stop and transmitter on periods as shown in Figure D.2.

Annex E (normative): Types and restrictions - set 1

Table E.1 provides the list of equipment covered by the present document and their key technical parameters based on the EC Decisions [i.3] and [i.5].

NOTE: See Table E.1 for the description of the types.

Table E.1: Types to be deployed in bands given in EC Decisions and corresponding restrictions

Type number	Equipment function in SRD data networks	Power (e.r.p.) mW	PFB	TxOFB	DC in the PFB	OBW requirement	Functional requirements	Reference
1	NAP	25	917,4 MHz to 919,4 MHz	917,4 MHz to 918,9 MHz	1 %	Less or equal to 600 kHz	NAP (clause 4.6.1)	Band 5 in Decision (EU) 2022/172 [i.5]
2	NAP	500	865 MHz to 868 MHz	865,6 MHz to 865,8 MHz	10 %	Less or equal to 200 kHz	NAP (clause 4.6.1) APC (clause 4.4.10)	Band 47b in Decision (EU) 2022/180 [i.3]
				866,2 MHz to 866,4 MHz				
				866,8 MHz to 867,0 MHz				
				867,4 MHz to 867,6 MHz				
NAP	500	917,3 MHz to 918,9 MHz	917,3 MHz to 917,7 MHz	10 %	Less or equal to 200 kHz	NAP (clause 4.6.1) APC (clause 4.4.10)	Band 4 in Decision (EU) 2022/172 [i.5]	
			918,5 MHz to 918,9 MHz					
3	Master NAP	25	917,4 MHz to 919,4 MHz	917,4 MHz to 918,9 MHz	1 %	Less or equal to 600 kHz	NAP (clause 4.6.1) Master NAP (clause 4.6.3)	Band 5 in Decision (EU) 2022/172 [i.5]
4	Master NAP	500	917,3 MHz to 918,9 MHz	917,3 MHz to 917,7 MHz	10 %	Less or equal to 200 kHz	NAP (clause 4.6.1) Master NAP (clause 4.6.3) APC (clause 4.4.10)	Band 4 in Decision (EU) 2022/172 [i.5]
				918,5 MHz to 918,9 MHz				
5	NN	25	917,4 MHz to 919,4 MHz	917,4 MHz to 918,9 MHz	1 %	Less or equal to 600 kHz		Band 5 in Decision (EU) 2022/172 [i.5]
6	NN	500	865 MHz to 868 MHz	865,6 MHz to 865,8 MHz	2,5 %	Less or equal to 200 kHz	APC (clause 4.4.10)	Band 47b in Decision (EU) 2022/180 [i.3]
				866,2 MHz to 866,4 MHz				
				866,8 MHz to 867,0 MHz				
				867,4 MHz to 867,6 MHz				
NN	500	917,3 MHz to 918,9 MHz	917,3 MHz to 917,7 MHz	2,5 %	Less or equal to 200 kHz	APC (clause 4.4.10)	Band 4 in Decision (EU) 2022/172 [i.5]	
			918,5 MHz to 918,9 MHz					

Type number	Equipment function in SRD data networks	Power (e.r.p.) mW	PFB	TxOFB	DC in the PFB	OBW requirement	Functional requirements	Reference
7	NN	25	917,4 MHz to 919,4 MHz	917,4 MHz to 918,9 MHz	1 %	Less or equal to 600 kHz	Under the control of a Master NAP (clause 4.6.2)	Band 5 in Decision (EU) 2022/172 [i.5]
8	NN	500	865 MHz to 868 MHz	865,6 MHz to 865,8 MHz	2,5 %	Less or equal to 200 kHz	APC (clause 4.4.10)	Band 47b in Decision (EU) 2022/180 [i.3]
				866,2 MHz to 866,4 MHz				
				866,8 MHz to 867,0 MHz				
				867,4 MHz to 867,6 MHz				
9	NN	500	917,3 MHz to 918,9 MHz	917,3 MHz to 917,7 MHz	2,5 %	Less or equal to 200 kHz	Under the control of a Master NAP (clause 4.6.2) APC (clause 4.4.10)	Band 4 in Decision (EU) 2022/172 [i.5]
				918,5 MHz to 918,9 MHz				
10	TN	25	917,4 MHz to 919,4 MHz	917,4 MHz to 918,9 MHz	1 %	Less or equal to 600 kHz		Band 5 in Decision (EU) 2022/172 [i.5]
11	TN	500	865 MHz to 868 MHz	865,6 MHz to 865,8 MHz	0,25 % (see note)	Less or equal to 200 kHz	APC (clause 4.4.10)	Band 47b in Decision (EU) 2022/180 [i.3]
				866,2 MHz to 866,4 MHz				
				866,8 MHz to 867,0 MHz				
				867,4 MHz to 867,6 MHz				
11	TN	500	917,3 MHz to 918,9 MHz	917,3 MHz to 917,7 MHz	0,25 % (see note)	Less or equal to 200 kHz	APC (clause 4.4.10)	Band 4 in Decision (EU) 2022/172 [i.5]
				918,5 MHz to 918,9 MHz				
12	TN	25	917,4 MHz to 919,4 MHz	917,4 MHz to 918,9 MHz	1 %	Less or equal to 600 kHz	Under the control of a Master NAP (clause 4.6.2)	Band 5 in Decision (EU) 2022/172 [i.5]
13	TN	500	865 MHz to 868 MHz	865,6 MHz to 865,8 MHz	0,25 % (see note)	Less or equal to 200 kHz	APC (clause 4.4.10)	Band 47b in Decision (EU) 2022/180 [i.3]
				866,2 MHz to 866,4 MHz				
				866,8 MHz to 867,0 MHz				
				867,4 MHz to 867,6 MHz				
14	TN	500	917,3 MHz to 918,9 MHz	917,3 MHz to 917,7 MHz	0,25 % (see note)	Less or equal to 200 kHz	Under the control of a Master NAP (clause 4.6.2) APC (clause 4.4.10)	Band 4 in Decision (EU) 2022/172 [i.5]
				918,5 MHz to 918,9 MHz				

NOTE: Terminal Node limit operated up to 500 mW is set to a value representative of average TN activity of 0,1 % assumed in CEPT spectrum compatibility studies (see [i.6], clause A.2.4). The limit reflects an expected distribution of TN activity with only a small percentile exceeding the modelled average.

Annex F (informative): Types and restrictions - set 2

In addition to EU wide harmonised radio interfaces listed in Table E.1, EU and EFTA member states may implement NRIs with associated technical requirements to ensure spectrum compatibility. Usually these requirements come from CEPT/ERC/REC 70-03 [i.4] which sets out the general position on spectrum designations for Short Range Devices (SRD) for countries within the CEPT. Table F.1 provides an indicative list of these NRIs which might be available in some EU countries. Manufacturers are advised to check the most recently published version of any given NRI (see at <https://efis.cept.org/>).

Table F.1: Types to be deployed in bands given in ERC Rec 70-03 [i.4] but not given in EC Decisions and the corresponding restrictions

Type number	Equipment function in SRD data networks	Power (e.r.p.) mW	PFB	TxOFB	DC in the PFB	OBW requirement	Functional requirements	Reference
1	NAP	25	915 MHz to 919,4 MHz	915 MHz to 919,4 MHz	1 %	Less or equal to 600 kHz	NAP (clause 4.6.1)	Band c4 in Annex 2
3	Master NAP	25	915 MHz to 919,4 MHz	915 MHz to 919,4 MHz	1 %	Less or equal to 600 kHz	NAP (clause 4.6.1) Master NAP (clause 4.6.3)	Band c4 in Annex 2
5	NN	25	915 MHz to 919,4 MHz	915 MHz to 919,4 MHz	1 %	Less or equal to 600 kHz		Band c4 in Annex 2
7	NN	25	915 MHz to 919,4 MHz	915 MHz to 919,4 MHz	1 %	Less or equal to 600 kHz	Under the control of a Master NAP (clause 4.6.2)	Band c4 in Annex 2
10	TN	25	915 MHz to 919,4 MHz	915 MHz to 919,4 MHz	1 %	Less or equal to 600 kHz		Band c4 in Annex 2
12	TN	25	915 MHz to 919,4 MHz	915 MHz to 919,4 MHz	1 %	Less or equal to 600 kHz	Under the control of Master NAP (clause 4.6.2)	Band c4 in Annex 2

NOTE: It should be noted that, in some countries, part or all of the band 915,0 MHz to 919,4 MHz may be unavailable, and/or other frequency bands may be available, for networked and/or network based short range devices. See National Radio Interfaces (NRI - see at <https://efis.cept.org/> as relevant for additional guidance.

Annex G (informative): Maximum measurement uncertainty

The measurements described in the present document are based on the following assumptions:

- the measured value related to the corresponding limit is used to decide whether an equipment meets the requirements of the present document;
- the value of the measurement uncertainty for the measurement of each parameter is included in the test report.

Table G.1 shows the recommended values for the maximum measurement uncertainty figures.

Table G.1: Maximum measurement uncertainty

Parameter	Uncertainty
Radio frequency	$\pm 0,5$ ppm
Radio frequency derived from OBW measurement	$\pm (0,5 \text{ ppm} + 2 \% \text{ of OBW})$
RF power, conducted	$\pm 1,5$ dB
Conducted spurious emission of transmitter, valid up to 6 GHz	± 3 dB
Conducted emission of receivers	± 3 dB
Radiated emission of transmitter, valid up to 6 GHz	± 6 dB
Radiated emission of receiver, valid up to 6 GHz	± 6 dB
RF level uncertainty for a given BER	$\pm 1,5$ dB
Temperature	± 1 °C
Humidity	± 10 %
Time	± 5 %

Annex H (informative): Guideline for Operating Channel

H.1 Operating channel calculation

This annex intends to help the reader to understand the concept of operating channel.

Nominal operating frequency and Operating Channel are EUT properties given by the intended use of the EUT. Nevertheless, operating channels have to comply with clause 4.2.3. These conditions are illustrated below.

Maximum Operating Channel Width value is a result of a calculation depending on the frequency offset between F_{nom} and the operating frequency band edges as provided in Table H.1.

Table H.1: Single nominal operating frequency EU

F_{nom}	Max value for OCW	Operating Channel edges
Any value between OFB_{low} and OFB_{high}	$2 \times \min((F_{nom} - OFB_{low}), (OFB_{high} - F_{nom}))$	$FOC_{low} = F_{nom} - \frac{OCW}{2}$ $FOC_{high} = F_{nom} + \frac{OCW}{2}$

Calculation for EUT with multiple (n) nominal operating frequencies is provided in Table H.2.

Table H.2: Multiple nominal operating frequency EUT

nom	Max value for OCW_n	Operating Channel edges
Any value between OFB_{low} and OFB_{high}	$2 \times \min((F_{nom_n} - OFB_{low}), (OFB_{high} - F_{nom_n}))$	$FOC_{low_n} = F_{nom_n} - \frac{OCW_n}{2}$ $FOC_{high_n} = F_{nom_n} + \frac{OCW_n}{2}$

H.2 Operating channel illustrations

Various examples to avoid misinterpretation by manufacturers and test laboratories are provided below.

Figure H.1 is an example of a single nominal operating frequency EUT, where the OCW is limited by the close proximity of the lower edge of the operating frequency band.

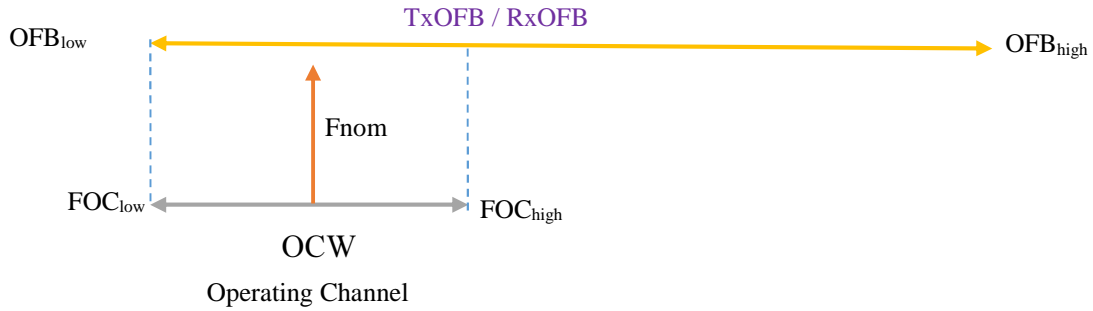

Figure H.1: Illustration of single nominal operating frequency EUT

Figure H.2 is an example of a single nominal operating frequency EUT, where the OCW is set by the intended use of the equipment.

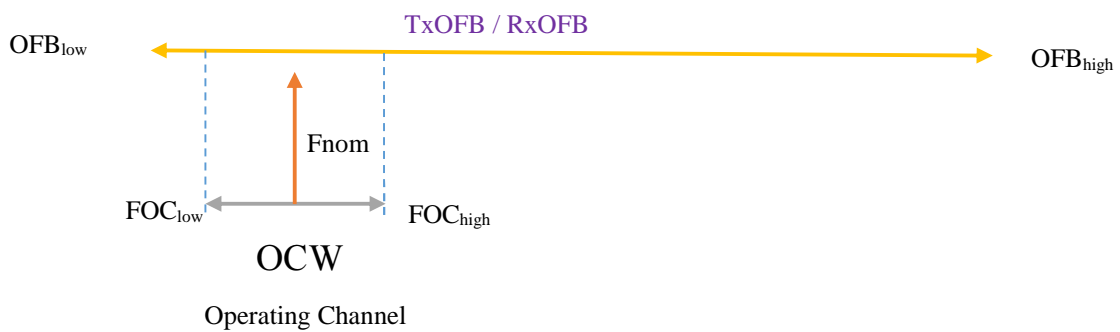

Figure H.2: Illustration of single nominal operating frequency EUT

Figure H.3 illustrates a single frequency EUT with an operating channel which is not allowed in the present document, since the transmission is not centered in the Operating Channel.

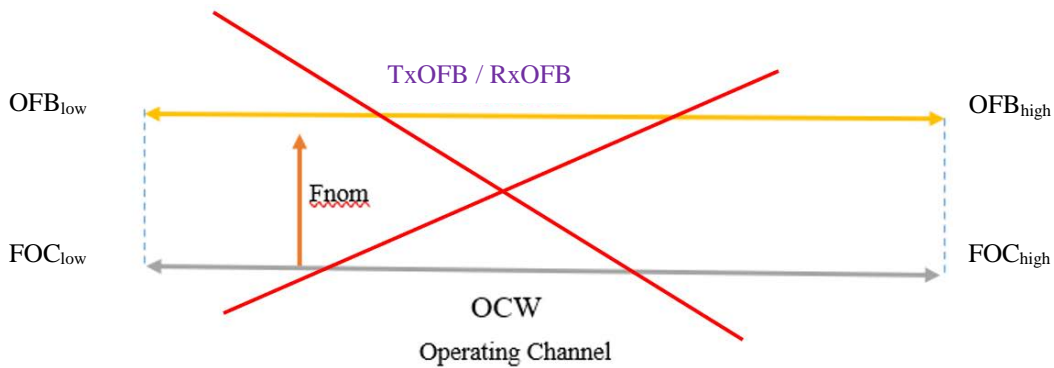

Figure H.3: Illustration of an incorrect OC for single nominal frequency EUT and single nominal operating frequency EUT

Figures H.4 illustrates a EUT with two operating channels, where OCW1 (resp. OCW2) is limited by the close proximity of the lower (resp. higher) edge of the operating frequency band.

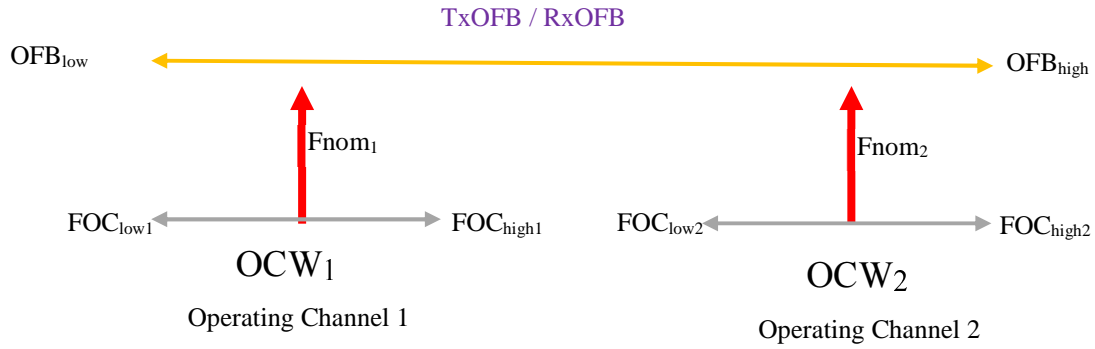

Figure H.4: Illustration of dual nominal operating frequency EUT

Figure H.5 illustrates a EUT with two operating channels, where their OCW are limited by the non-overlapping requirement of operating channels (i.e. contiguous channels).

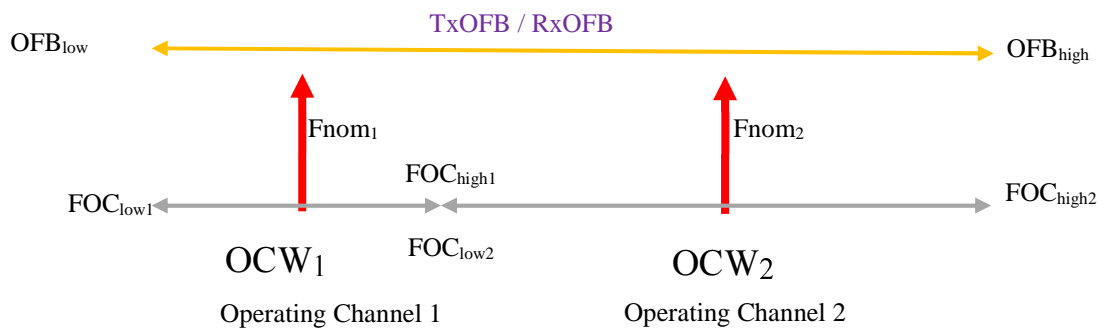

Figure H.5: Illustration of dual nominal operating frequency EUT

EUT transmission using a modulation with sub-carriers in an operating channel is illustrated in Figure H.6.

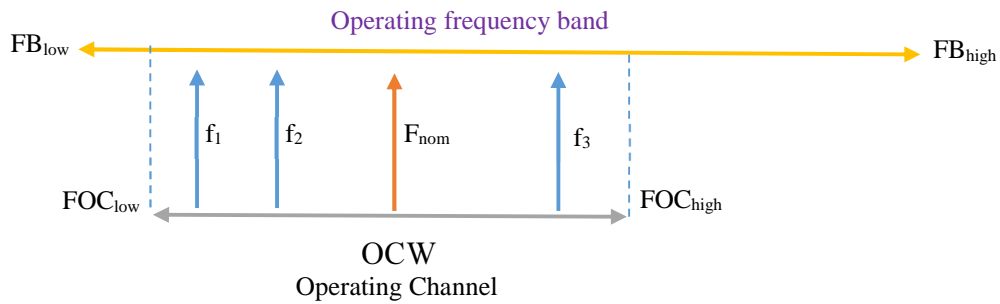

Figure H.6: Illustration of EUT using sub-carrier modulation in an operating channel

Annex I (informative): Properties of EUT

I.1 Rights to copy

Notwithstanding the provisions of the copyright clause related to the text of the present document, ETSI grants that users of the present document may freely reproduce the form in this annex so that it can be used for its intended purposes and may further publish the completed form.

I.2 EUT Properties

This annex lists the EUT properties necessary for the execution of the conformance test suites used to determine the conformance of the EUT. This application form should form an integral part of the test report.

Property	Value	Units
Permitted Frequency Band		MHz
Nominal operating frequency (ies) Specify the nominal operating frequencies OC of the transmitter part and of the receiver part separately.		MHz
Operating channel(s), FOC _{low} and FOC _{high} of each OC Specify the OC of the transmitter part and of the receiver part separately.		MHz
EUT data rate (R)		kbps
Technical description of D-M2, D-M3 (Information necessary to be able to synthesize test signals representative of intended use)		
Unmodulated carrier, if the equipment is able to generate test signal D-M1 or not	<input type="checkbox"/> Yes <input type="checkbox"/> No	
Disregard time ($T_{\text{disregard}}$)		ms
Nominal mains voltage (or range of voltages)		Vac
Nominal battery voltage		V
APC settling time		μ s
Upper and lower voltage range from environmental profile given by the intended use		V
Upper and lower temperatures of the environmental profile given by the intended use		$^{\circ}$ C

Annex J (informative): Selection of technical parameters

ETSI EG 203 336 [i.12], clause 5 lists the technical parameters applicable to transmitters and receivers that should be considered when producing Harmonised Standards that are intended to cover the essential requirements in article 3.2 of Directive 2014/53/EU [i.2]. Essential requirements are high level objectives described in European Directives. The purpose of the Harmonised Standard is to translate those high level objectives into detailed technical specifications. Table J.1 contains the parameters listed in ETSI EG 203 336 [i.12], clause 5 for transmitter and receiver, and cross references these to the clauses within the present document in which the requirements for measurement of such parameters are satisfied or justified.

Table J.1: Cross reference of clauses in the present document to technical parameters for transmitter and receiver listed in ETSI EG 203 336 [i.12]

ETSI EG 203 336 [i.12]		Present document		Justification
Clause	Parameter	Clause	Parameter	
5.2.2	Transmitter power limits	4.4.1	Effective radiated power	
5.2.3	Transmitter power accuracy	-	-	From the latest version of ETSI EG 203 336 [i.12] "When regulatory limits imply only a maximum emission limit (e.g. products that operate under a general licence regime), this parameter need not be considered for inclusion in an HS."
5.2.4	Transmitter spectrum mask	4.4.2 4.4.7 4.4.8	Maximum occupied bandwidth Adjacent channel power Spectrum mask at permitted frequency band edges	
5.2.5	Transmitter frequency stability	4.4.3 4.4.4	Frequency error Transmitter Signal at the edge of the TxOFB	
5.2.6	Transmitter intermodulation attenuation	-	-	From latest version of ETSI EG 203 336 [i.12] this parameter is required only "where high levels of quality services are required". This is not relevant for networked SRDs which are operating in many countries under licence except regime without any kind of regulatory protection. Networked SRDs have to accept interferences. Equipment in the scope is also limited to low power not exceeding 500 mW.
5.2.7.2	Transmitter unwanted emissions in the out of band domain	4.4.6	Spectrum mask in the transmitter out-of-band domain	
5.2.7.3	Transmitter unwanted emissions in the spurious domain	4.3.1	Unwanted emissions in the spurious domain	
5.2.8	Transmitter time domain characteristics	4.4.9	Duty cycle	
5.2.9	Transmitter transients	4.4.5	Transient power	
5.3.2	Receiver sensitivity	4.5.1	Receiver sensitivity	
5.3.2.3	Desensitization	4.5.2 4.5.4	Adjacent channel selectivity Blocking	From latest version of ETSI EG 203 336 [i.12] "As desensitization is a receiver effect addressed by other parameters, its inclusion as a separate parameter in an HS is not required."

ETSI EG 203 336 [i.12]		Present document		Justification
Clause	Parameter	Clause	Parameter	
5.3.3	Receiver co-channel rejection	-	-	Receiver co-channel rejection (ETSI EG 203 336 [i.12], clause 5.3.3) is a measure of the capability of a receiver to receive a wanted signal, without exceeding a given degradation, due to the presence of an unwanted signal, both signals being at the nominal frequency of the receiver. Co Channel rejection is dependent on the receiver design and the method of demodulation used. There is a fundamental limit to the value achievable that is set by the modulation format. More advanced modulation formats deliver higher data rates for a given bandwidth but require lower unwanted energy in the channel. This also has the benefit of reducing the "over the air time" thereby ensuring better spectrum sharing. Specifying receiver co-channel performance has benefits when planning systems of similar devices where the modulation format is known. The present document is intended to cover different types of devices, in a range of different data networks. All kinds of modulations are allowed in order to allow for innovation. Given that the modulation format is not specified, it was decided not to include a requirement for receiver co-channel rejection.
5.3.4.2.1	Receiver adjacent channel selectivity	4.5.2	Adjacent channel selectivity	Adjacent channel selectivity is also covering desensitization.
5.3.4.2.2	Receiver adjacent band selectivity	4.5.2 4.5.4	Adjacent channel selectivity Blocking	
5.3.4.3	Receiver blocking	4.5.4	Blocking	Blocking is also covering desensitization.
5.3.4.4	Receiver spurious response rejection	4.5.3	Spurious response rejection	
5.3.4.5	Receiver radio-frequency intermodulation	-	-	Intermodulation rejection is a measure of the ability of a receiver to operate in the presence of two or more unwanted signals the frequencies of which have a specific frequency relationship to the wanted signal. Intermodulation effects will manifest themselves as blocking effects and the present document relies on limits and test suites for blocking and adjacent channel selectivity to ensure receiver resilience in the shared spectrum environment.
5.3.5	Receiver unwanted emissions in the spurious domain	4.3.1	Unwanted emissions in the spurious domain	
5.3.6.1	Receiver dynamic range	4.5.1, 4.5.2, 4.5.4 and 4.5.5	Receiver sensitivity Adjacent channel selectivity Blocking Receiver maximum input signal level	From latest version of ETSI EG 203 336 [i.12] "Receiver dynamic range is defined as the range of the wanted input signal level over which a receiver functions at a specified performance level. The lower end of this range is normally the sensitivity of the receiver. The upper end of a receiver's dynamic range determines how strong a received signal can be before producing degradation due to overloading." This parameter sets targets for both minimum sensitivity (clause 4.5.1) and receiver maximum input maximum signal strength (clause 4.5.5) and so, implicitly, receiver dynamic range. Furthermore, the dynamic range of the receiver is implicitly covered by interference characteristics being specified in terms of selectivity requirements, adjacent channel selectivity (clause 4.5.2) and blocking (clause 4.5.5).

ETSI EG 203 336 [i.12]		Present document		Justification
Clause	Parameter	Clause	Parameter	
5.3.6.2	Reciprocal mixing	4.5.2 4.5.4	Adjacent channel selectivity Blocking	It is considered that reciprocal mixing effects (ERC Recommendation 70-03 [i.4], clause 5.3.6.2) manifest themselves as blocking effects and the present document relies on limits and test suites for blocking requirement (clause 4.5.4) and adjacent channel selectivity requirement (clause 4.5.2) to ensure receiver resilience in the shared spectrum environment. Reciprocal mixing is an effect within a receiver that limits performance rather than a parameter that can be measured on a complete networked SRD receiver.
5.3.1	Signal interferer handling	-	-	Signal interferer handling (ETSI EG 203 336 [i.12], clause 5.3.1) is an alternative method for specifying receiver parameters intended for use for receivers such as UWB and certain types of radar equipment. The present document is intended for communications equipment and specifies receiver requirements and measurement methods for all receiver parameters listed above instead of signal interferer handling.

Annex K (informative): Applications of the masks given in clauses 4.3.1, 4.4.6 and 4.4.8

Figures K.1 to K.6 provides examples of transmission mask considering the requirements given in clauses 4.3.1.2.1 (spectrum mask in the transmitter spurious domain), 4.4.6 (spectrum mask in the transmitter out-of-band domain) and 4.4.8 (spectrum mask at permitted frequency band edges).

Figure K.1 provides an example for the case of a 25 mW device with 200 kHz OCW operated at 915,3 MHz (types 1, 3, 5, 7, 10 and 12).

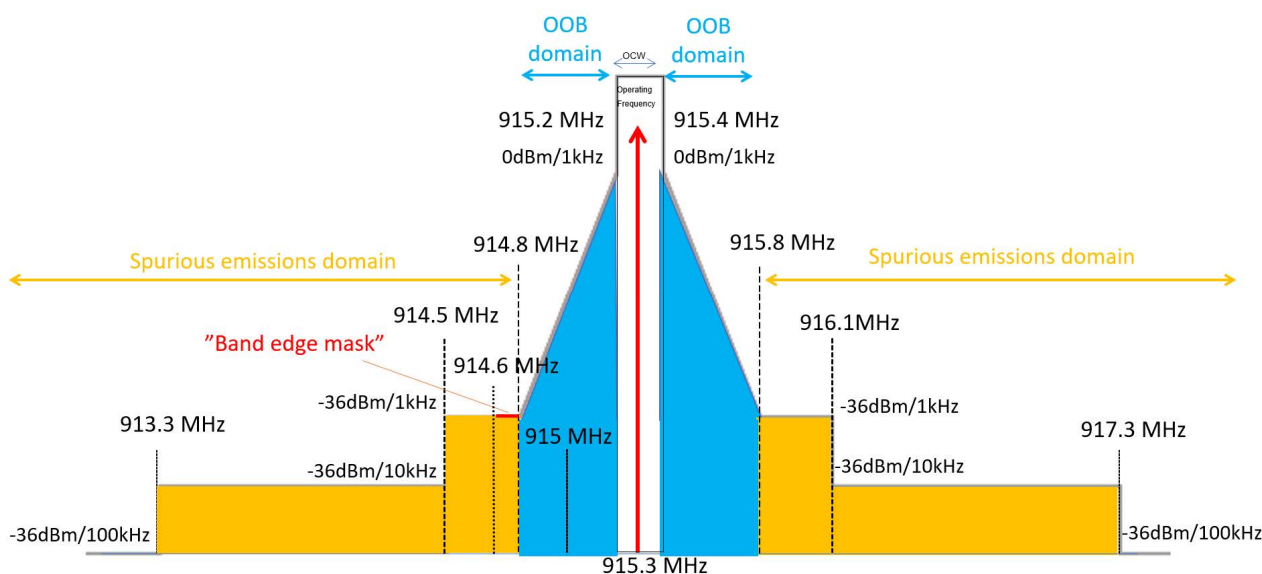

Figure K.1: 25 mW device with 200 kHz OCW operated at 915,3 MHz

Figure K.2 provides an example for the case of a 25 mW device with 200 kHz OCW operated at 919,3 MHz (types 1, 3, 5, 7, 10 and 12).

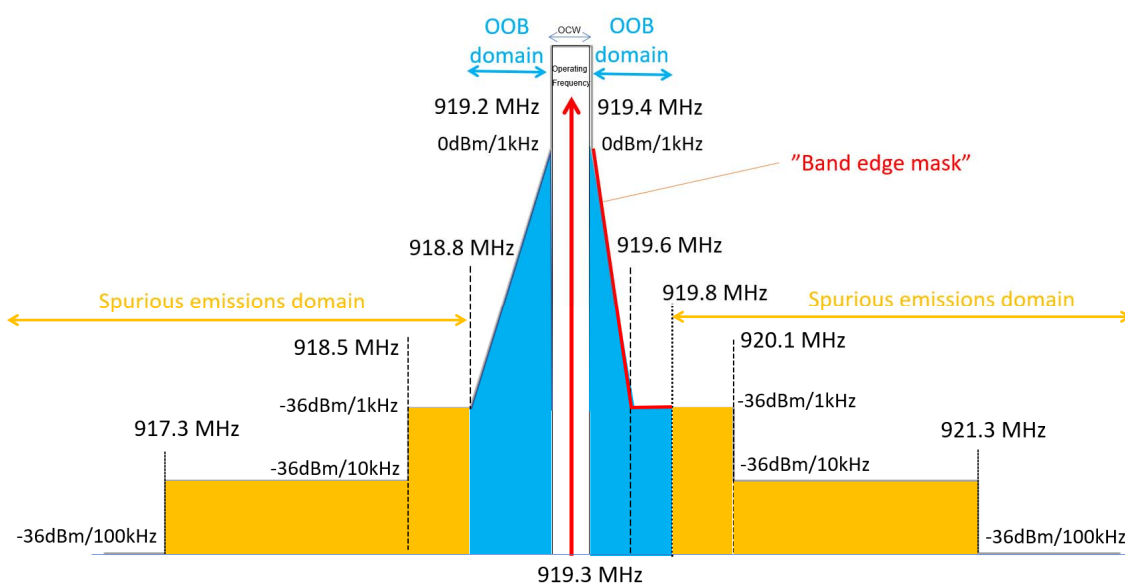

Figure K.2: 25 mW device with 200 kHz OCW operated at 919,3 MHz

Figure K.3 provides an example for the case of a 25 mW device with 600 kHz OCW operated at 918 MHz (types 1, 3, 5, 7, 10 and 12).

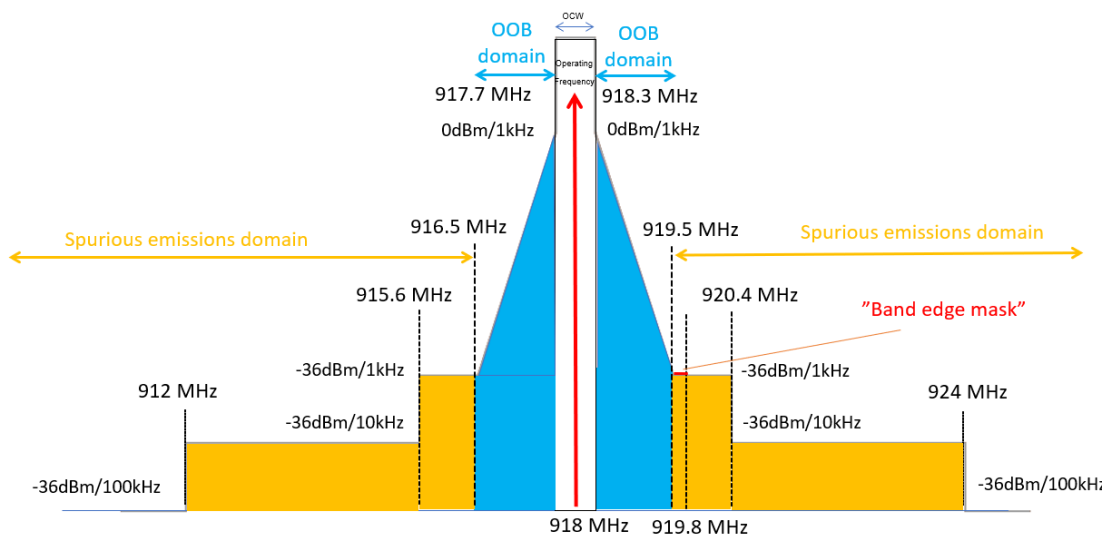

Figure K.3: 25 mW device with 600 kHz OCW operated at 918 MHz

Figure K.4 provides an example for the case of a 500 mW device with 200 kHz OCW operated at 917,4 MHz (types 2, 4, 6, 9, 11, or 14).

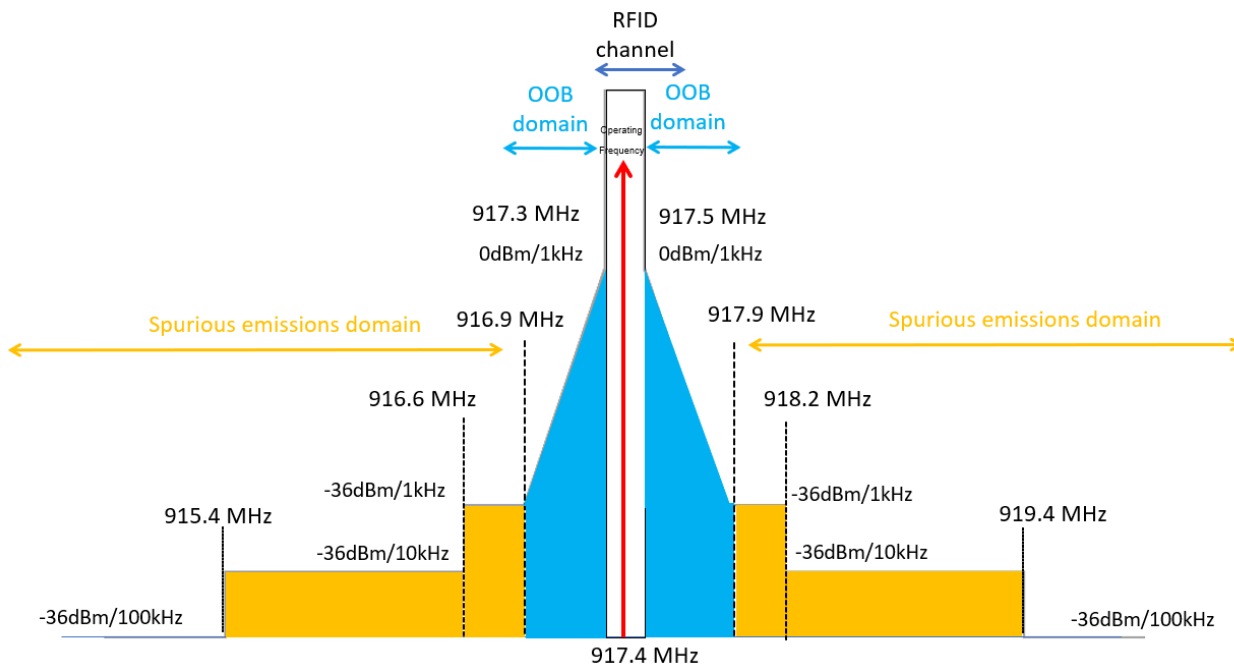

Figure K.4: 500 mW device with 200 kHz OCW operated at 917,4 MHz

Figure K.5 provides an example for the case of a 25 mW device with 600 kHz OCW operated at 917 MHz (types 1, 3, 5, 7, 10 and 12).

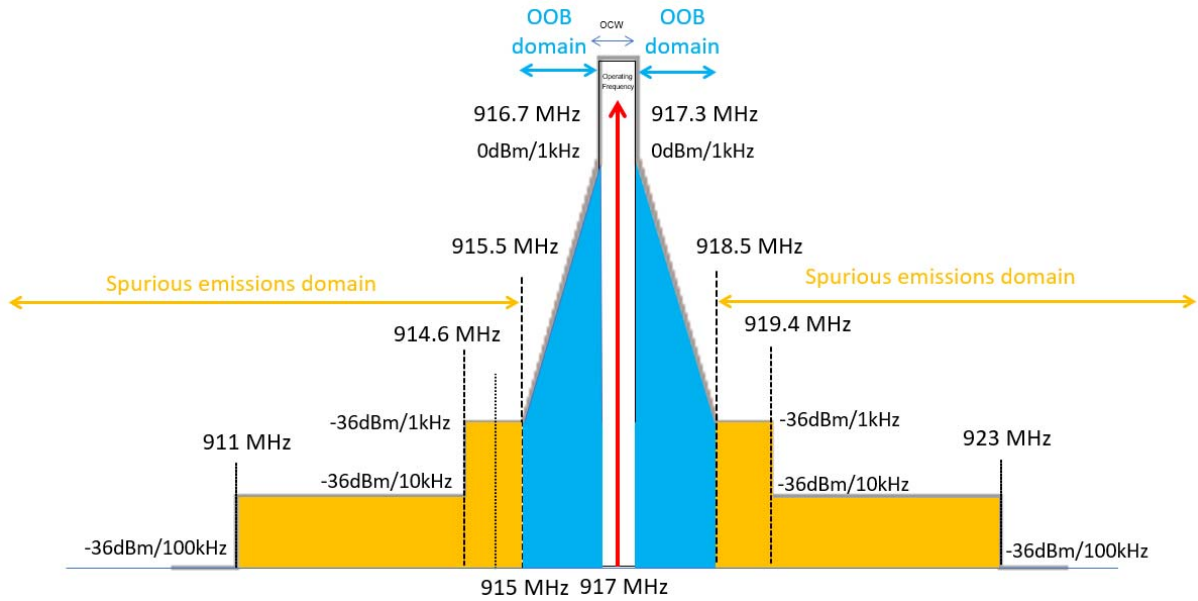

Figure K.5: 25 mW device with 600 kHz OCW operated at 917 MHz

Figure K.6 provides an example for the case of a 25 mW device with 50 kHz OCW operated at 919,375 MHz (types 1, 3, 5, 7, 10 and 12).

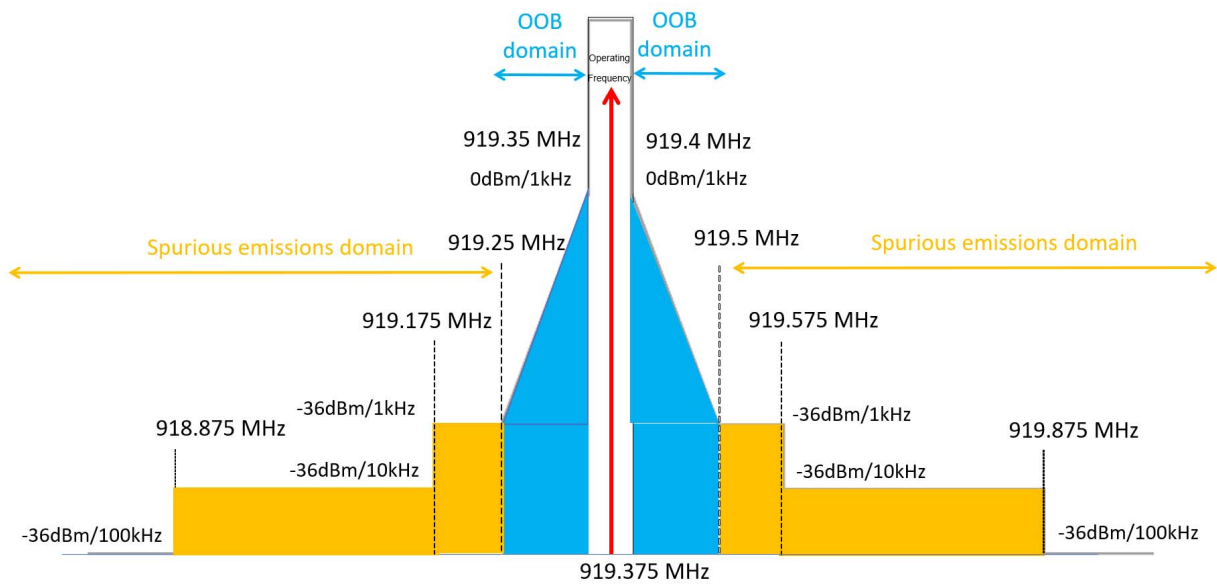

Figure K.6: 25 mW device with 50 kHz OCW operated at 919,375 MHz

Annex L (informative): Change history

Version	Information about changes
1.1.1	First published version

History

Document history			
V1.0.0	November 2024	EN Approval Procedure	EV 20250219: 2024-11-21 to 2025-02-19